

2014



CONTRACTOR'S BOOK



Page	Description
3	29 Gauge Tru-D-Rib
4	26 Gauge Tru-D-Rib, Closures, Profile Vent, Related Products
5	29 Gauge Tru-A-Panel
6	26 Gauge Tru-A-Panel, Closures, Profile Vent, Related Products
7	29 Gauge Tru-Panel Rib
8-16	Trims
17-19	Screws & Fasteners
20	Door Hardware Flashers Nutseter & Door Locks
21	Windows Ridgevents Cupolas Insulation Silicone & Butyl Tape
22	Side Raid Bottom Rail - H - Rail & Square Track
23	Roll Valley Flashing & Roof Edge
24-27	Pro Trims, 1/2" Soffits
28	Soffit Panels Tru-D-Rib & Tru-A-Panel
29	Residential Soffits

Handling & Storage

If storage is to be for a day or two, keep the metal inside in the bundle up off the ground on blocks. Metal should be spread or fanned out at their bottom ends to allow for air inside in the bundle up off the ground on blocks. Failure to follow these steps may result in wet storage stain and premature white rusting, which the manufacturer cannot be held responsible for. If Galvanized sheets are to be stored for any period of time, they should be unbundled and stood on end against an interior wall.

Return Policy

There will be no returns accepted without a return memo and there will be a 25% restocking charge. Material must be wrapped and in saleable condition, no returns after 60 days. Job cut steel will not be available to return.

Useful Tips

When using a power saw to cut metal panels several precautions should be taken. Place the bottom interior surface of the sheet up and cover with a tarp to protect the top exterior surface from the hot metal filings and reduce the chance of damage. When doing the actual cutting, be sure to wear protective eye glasses and do it away from other unused or applied panels. Metal filings may become embedded in the surface of the sheet and if left alone will quickly rust. Be sure to swipe all filing from both surfaces before application.

HAVE QUESTIONS? GIVE US A CALL TODAY AT 1-877-822-3530.



29 GAUGE TRU-D-RIB

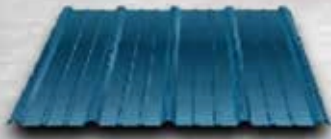

Name	Item #	Description	per lin 1"	per sq. ft	per lin ft
Tru-D-Rib	WTR10	Galvanized	\$0.00000	\$0.0000	\$0.000
Tru-D-Rib	WTR11	White	\$0.00000	\$0.0000	\$0.000
Tru-D-Rib	WTR12	Green	\$0.00000	\$0.0000	\$0.000
Tru-D-Rib	WTR13	Lightstone	\$0.00000	\$0.0000	\$0.000
Tru-D-Rib	WTR14	Taupe	\$0.00000	\$0.0000	\$0.000
Tru-D-Rib	WTR15	Ash Gray	\$0.00000	\$0.0000	\$0.000
Tru-D-Rib	WTR16	Ocean Blue	\$0.00000	\$0.0000	\$0.000
Tru-D-Rib	WTR17	Tan	\$0.00000	\$0.0000	\$0.000
Tru-D-Rib	WTR18	Charcoal Gray	\$0.00000	\$0.0000	\$0.000
Tru-D-Rib	WTR19	Red	\$0.00000	\$0.0000	\$0.000
Tru-D-Rib	WTR20	Brown	\$0.00000	\$0.0000	\$0.000
Tru-D-Rib	WTR21	Black	\$0.00000	\$0.0000	\$0.000
Tru-D-Rib	WTR22	Burgundy	\$0.00000	\$0.0000	\$0.000
Tru-D-Rib	WTR23	Bone White	\$0.00000	\$0.0000	\$0.000
Tru-D-Rib	WTR24	Antique Bronze	\$0.00000	\$0.0000	\$0.000
Tru-D-Rib	WTR25	Brite Red	\$0.00000	\$0.0000	\$0.000
Tru-D-Rib	WTR27	Dark Blue	\$0.00000	\$0.0000	\$0.000
Tru-D-Rib	WTR28	Pewter	\$0.00000	\$0.0000	\$0.000
Tru-D-Rib	WTR29	Forest Green	\$0.00000	\$0.0000	\$0.000
Tru-D-Rib	WTR50	Copper Penny	\$0.00000	\$0.0000	\$0.000
Tru-D-Rib	WTR38	Liner Panel White	\$0.00000	\$0.0000	\$0.000
Tru-D-Rib	WTR36	Perforated	\$0.00000	\$0.0000	\$0.000
Tru-D-Rib	WTR30	Diamond Embossed Aluminum Bare	Call		
Tru-D-Rib	WTR31	Aluminum White	Call		
Tru-D-Rib	WTR760	8' Skylite	\$00.00		
Tru-D-Rib	WTR770	10' Poly Carb Clear Panel	\$00.00		
Tru-D-Rib	WTR780	12' Poly Carb Clear Panel	\$00.00		
Tru-D-Rib	WTR790	16' Poly Carb Clear Panel	\$00.00		

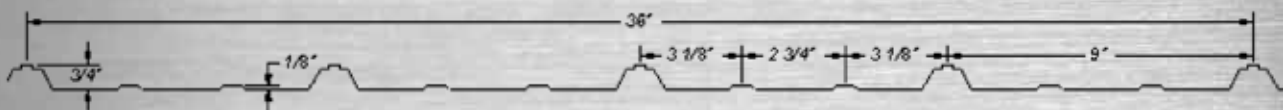

HAVE QUESTIONS? GIVE US A CALL TODAY AT 1-877-822-3530.



FAX US YOUR ORDERS AT (701) 749-5304 OR (701) 212-4392

26 GAUGE TRU-D-RIB



Name	Item #	Description	per lin 1"	per sq. ft	per lin ft
Tru-D-Rib	WTR60	Galvanized	\$0.00000	\$0.0000	\$0.000
Tru-D-Rib	WTR61	White	\$0.00000	\$0.0000	\$0.000
Tru-D-Rib	WTR62	Green	\$0.00000	\$0.0000	\$0.000
Tru-D-Rib	WTR63	Lightstone	\$0.00000	\$0.0000	\$0.000
Tru-D-Rib	WTR64	Taupe	\$0.00000	\$0.0000	\$0.000
Tru-D-Rib	WTR65	Ash Gray	\$0.00000	\$0.0000	\$0.000
Tru-D-Rib	WTR66	Ocean Blue	\$0.00000	\$0.0000	\$0.000
Tru-D-Rib	WTR67	Tan	\$0.00000	\$0.0000	\$0.000
Tru-D-Rib	WTR68	Charcoal Gray	\$0.00000	\$0.0000	\$0.000
Tru-D-Rib	WTR69	Red	\$0.00000	\$0.0000	\$0.000
Tru-D-Rib	WTR70	Brown	\$0.00000	\$0.0000	\$0.000
Tru-D-Rib	WTR72	Burgundy	\$0.00000	\$0.0000	\$0.000
Tru-D-Rib	WTR78	Pewter	\$0.00000	\$0.0000	\$0.000
Tru-D-Rib	WTR79	Forest Green	\$0.00000	\$0.0000	\$0.000

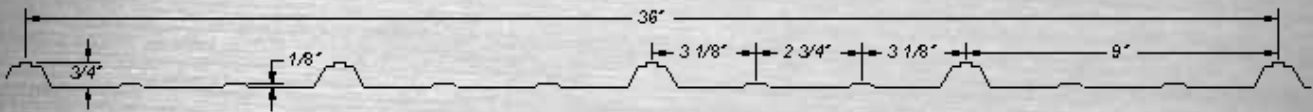

CLOSURES

Name	Item #	Description	Price
Tru-D-Rib	WTR90	Large Outside Enclosures	\$0.00
Tru-D-Rib	WTR91	Small Inside Enclosures	\$0.00

PROFILE VENT

Name	Item #	Description	Price
WV 85	10' VersaVent Profile		\$0.00
WTR 85	Tru-D-Rib Low Profile Vent		\$0.00

RELATED PRODUCTS

Name	Item #	Description	Price
WUS10	1" x 1" Uniseal 20' Roll		\$0.00
WCUT	Cutting Charge Under 48"		\$0.00
Wflatstock	Flat Stock 26 ga. 4' x 10' x 6"		\$0.00

HAVE QUESTIONS? GIVE US A CALL TODAY AT 1-877-822-3530.



29 GAUGE TRU-A-PANEL



Name	Item #	Description	per lin 1"	per sq. ft	per lin ft
Tru-A-Panel	WTP10	Galvanized	\$0.00000	\$0.0000	\$0.000
Tru-A-Panel	WTP11	White	\$0.00000	\$0.0000	\$0.000
Tru-A-Panel	WTP12	Green	\$0.00000	\$0.0000	\$0.000
Tru-A-Panel	WTP13	Lightstone	\$0.00000	\$0.0000	\$0.000
Tru-A-Panel	WTP14	Taupe	\$0.00000	\$0.0000	\$0.000
Tru-A-Panel	WTP15	Ash Gray	\$0.00000	\$0.0000	\$0.000
Tru-A-Panel	WTP16	Ocean Blue	\$0.00000	\$0.0000	\$0.000
Tru-A-Panel	WTP17	Tan	\$0.00000	\$0.0000	\$0.000
Tru-A-Panel	WTP18	Charcoal Gray	\$0.00000	\$0.0000	\$0.000
Tru-A-Panel	WTP19	Red	\$0.00000	\$0.0000	\$0.000
Tru-A-Panel	WTP20	Brown	\$0.00000	\$0.0000	\$0.000
Tru-A-Panel	WTP21	Black	\$0.00000	\$0.0000	\$0.000
Tru-A-Panel	WTP22	Burgundy	\$0.00000	\$0.0000	\$0.000
Tru-A-Panel	WTP23	Bone White	\$0.00000	\$0.0000	\$0.000
Tru-A-Panel	WTP24	Antique Bronze	\$0.00000	\$0.0000	\$0.000
Tru-A-Panel	WTP25	Brite Red	\$0.00000	\$0.0000	\$0.000
Tru-A-Panel	WTP27	Dark Blue	\$0.00000	\$0.0000	\$0.000
Tru-A-Panel	WTP28	Pewter	\$0.00000	\$0.0000	\$0.000
Tru-A-Panel	WTP29	Forest Green	\$0.00000	\$0.0000	\$0.000
Tru-A-Panel	WTP50	Copper Penny	\$0.00000	\$0.0000	\$0.000
Tru-A-Panel	WTP38	Liner Panel White	\$0.00000	\$0.0000	\$0.000
Tru-A-Panel	WTP36	Perforated	\$0.00000	\$0.0000	\$0.000
Tru-A-Panel	WTP30	Embossed Aluminum Bare	Call		
Tru-A-Panel	WTP31	Aluminum White	Call		
Tru-A-Panel	WTP95	8' Poly Carb Clear Panel	\$00.00		
Tru-A-Panel	WTP98	12' Poly Carb Clear Panel	\$00.00		

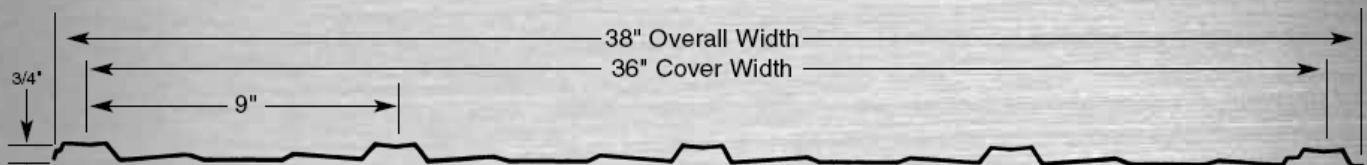

HAVE QUESTIONS? GIVE US A CALL TODAY AT 1-877-822-3530.



FAX US YOUR ORDERS AT (701) 749-5304 OR (701) 212-4392

26 GAUGE TRU-A-PANEL

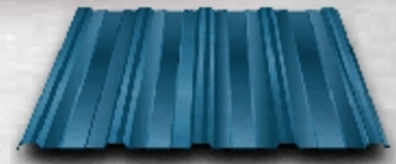

Name	Item #	Description	per lin 1"	per sq. ft	per lin ft
Tru-A-Panel	WTP60	Galvanized	\$0.00000	\$0.0000	\$0.000
Tru-A-Panel	WTP61	White	\$0.00000	\$0.0000	\$0.000
Tru-A-Panel	WTP62	Green	\$0.00000	\$0.0000	\$0.000
Tru-A-Panel	WTP63	Lightstone	\$0.00000	\$0.0000	\$0.000
Tru-A-Panel	WTP64	Taupe	\$0.00000	\$0.0000	\$0.000
Tru-A-Panel	WTP65	Ash Gray	\$0.00000	\$0.0000	\$0.000
Tru-A-Panel	WTP66	Ocean Blue	\$0.00000	\$0.0000	\$0.000
Tru-A-Panel	WTP67	Tan	\$0.00000	\$0.0000	\$0.000
Tru-A-Panel	WTP68	Charcoal Gray	\$0.00000	\$0.0000	\$0.000
Tru-A-Panel	WTP69	Red	\$0.00000	\$0.0000	\$0.000
Tru-A-Panel	WTP70	Brown	\$0.00000	\$0.0000	\$0.000
Tru-A-Panel	WTP72	Burgundy	\$0.00000	\$0.0000	\$0.000
Tru-A-Panel	WTP78	Pewter	\$0.00000	\$0.0000	\$0.000
Tru-A-Panel	WTP79	Forest Green	\$0.00000	\$0.0000	\$0.000

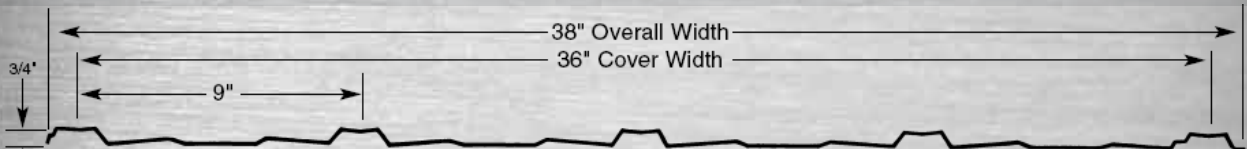

CLOSURES

Name	Item #	Description	Price
Tru-A-Panel	WTP90	Large Outside Enclosures	\$0.00
Tru-A-Panel	WTP91	Small Inside Enclosures	\$0.00

PROFILE VENT

Name	Item #	Description	Price
WV 85	10' VersaVent Profile		\$0.00
WTP 85	Tru-A-Panel Low Profile Vent		\$0.00

RELATED PRODUCTS

Name	Item #	Description	Price
WUS10	1" x 1" Uniseal 20' Roll		\$0.00
WCUT	Cutting Charge Under 48"		\$0.00
Wflatstock	Flat Stock 26 ga. 4' x 10' x 6"		\$0.00

HAVE QUESTIONS? GIVE US A CALL TODAY AT 1-877-822-3530.



29 GAUGE TRU-PANEL-RIB

Name	Item #	Description	per lin 1"	per sq. ft	per lin ft
WPD10	Tru-Panel-Rib	Galvanized	\$0.00000	\$0.00000	\$0.000
WPD11	Tru-Panel-Rib	White	\$0.00000	\$0.00000	\$0.000
WPD12	Tru-Panel-Rib	Green	\$0.00000	\$0.00000	\$0.000
WPD13	Tru-Panel-Rib	Lightstone	\$0.00000	\$0.00000	\$0.000
WPD14	Tru-Panel-Rib	Taupe	\$0.00000	\$0.00000	\$0.000
WPD15	Tru-Panel-Rib	Ash Gray	\$0.00000	\$0.00000	\$0.000
WPD18	Tru-Panel-Rib	Charcoal Gray	\$0.00000	\$0.00000	\$0.000
WPD19	Tru-Panel-Rib	Red	\$0.00000	\$0.00000	\$0.000
WPD20	Tru-Panel-Rib	Brown	\$0.00000	\$0.00000	\$0.000
WPD22	Tru-Panel-Rib	Burgundy	\$0.00000	\$0.00000	\$0.000

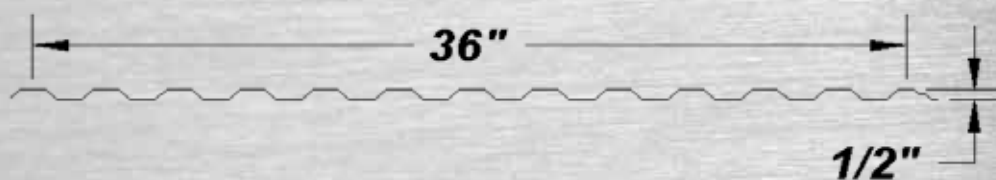

Name		
WPD98	Panel-Rib 12' Skylite	\$0.00

CLOSURES

Name	Item #	Description	
WPD90	Panel-Rib Closures		\$0.00



PROFILE VENT

Name	Item #	Description	
WV85	10' VersaVent Profile		\$0.00
WUS10	1" x 1" Uniseal 20' Roll		\$0.00
WCUT	Cutting Charge Under 48"		\$0.00
Wflatstock	Flat Stock 26 ga. 4' x 10' x 6"		\$0.00



HAVE QUESTIONS? GIVE US A CALL TODAY AT 1-877-822-3530.



FAX US YOUR ORDERS AT (701) 749-5304 OR (701) 212-4392

RAKE CORNER/TRIM

10'6" 12'6" 14'6" 16'6" 18'6" 5-1/2" X 5-1/2" RAKE & CORNER

WRAK10	\$00.00	WRAK40	\$00.00	WRAK60	\$00.00	WRAK80	\$00.00	WRAK100	\$00.00
WRAK11	\$00.00	WRAK41	\$00.00	WRAK61	\$00.00	WRAK81	\$00.00	WRAK101	\$00.00
WRAK12		WRAK42		WRAK62		WRAK82		WRAK102	
WRAK13		WRAK43		WRAK63		WRAK83		WRAK103	
WRAK14		WRAK44		WRAK64		WRAK84		WRAK104	
WRAK15		WRAK45		WRAK65		WRAK85		WRAK105	
WRAK16		WRAK46		WRAK66		WRAK86		WRAK106	
WRAK17		WRAK47		WRAK67		WRAK87		WRAK107	
WRAK18		WRAK48		WRAK68		WRAK88		WRAK108	
WRAK19		WRAK49		WRAK69		WRAK89		WRAK109	
WRAK20		WRAK50		WRAK70		WRAK90		WRAK110	
WRAK21		WRAK51		WRAK71		WRAK91		WRAK111	
WRAK22		WRAK52		WRAK72		WRAK92		WRAK112	
WRAK23		WRAK53		WRAK73		WRAK93		WRAK113	
WRAK24		WRAK54		WRAK74		WRAK94		WRAK114	
WRAK25		WRAK55		WRAK75		WRAK95		WRAK115	
WRAK27		WRAK57		WRAK77		WRAK97		WRAK117	
WRAK28		WRAK58		WRAK78		WRAK98		WRAK118	
WRAK29		WRAK59		WRAK79		WRAK99		WRAK119	
WRAK30		WRAK31		WRAK32		WRAK33		WRAK120	

- Galvanized
- White
- Green
- Lightstone
- Taupe
- Ash Gray
- Ocean Blue
- Tan
- Charcoal Gray
- Red
- Brown
- Black
- Burgundy
- Bone White
- Antique Bronze
- Brite Red
- Dark Blue
- Pewter
- Forest Green
- Copper Penny

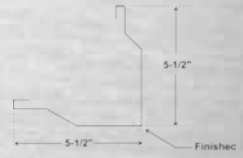

10'6" 12'6" 14'3" 16'3" 3-1/2" X 3-1/2" RAKE & CORNER

WRC10	\$00.00	WRC40	\$00.00	WRC60	\$00.00	WRC80	\$00.00
WRC11	\$00.00	WRC41	\$00.00	WRC61	\$00.00	WRC81	\$00.00
WRC12		WRC42		WRC62		WRC82	
WRC13		WRC43		WRC63		WRC83	
WRC14		WRC44		WRC64		WRC84	
WRC15		WRC45		WRC65		WRC85	
WRC16		WRC46		WRC66		WRC86	
WRC17		WRC47		WRC67		WRC87	
WRC18		WRC48		WRC68		WRC88	
WRC19		WRC49		WRC69		WRC89	
WRC20		WRC50		WRC70		WRC90	
WRC21		WRC51		WRC71		WRC91	
WRC22		WRC52		WRC72		WRC92	
WRC23		WRC53		WRC73		WRC93	
WRC24		WRC54		WRC74		WRC94	
WRC25		WRC55		WRC75		WRC95	
WRC27		WRC57		WRC77		WRC97	
WRC28		WRC58		WRC78		WRC98	
WRC29		WRC59		WRC79		WRC99	
WRC30		WRC31		WRC32		WRC33	

- Galvanized
- White
- Green
- Lightstone
- Taupe
- Ash Gray
- Ocean Blue
- Tan
- Charcoal Gray
- Red
- Brown
- Black
- Burgundy
- Bone White
- Antique Bronze
- Brite Red
- Dark Blue
- Pewter
- Forest Green
- Copper Penny

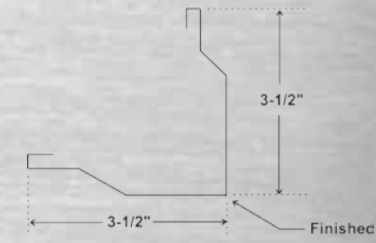

10'6" 3-1/2" X 5-1/2" RAKE TRIM 10'6" 7-1/2" X 5-1/2" RAKE TRIM

WRT10	\$00.00	Galvanized
WRT11	\$00.00	White
WRT12		Green
WRT13		Lightstone
WRT14		Taupe
WRT15		Ash Gray
WRT16		Ocean Blue
WRT17		Tan
WRT18		Charcoal Gray
WRT19		Red
WRT20		Brown
WRT21		Black
WRT22		Burgundy
WRT23		Bone White
WRT24		Antique Bronze
WRT25		Brite Red
WRT27		Dark Blue
WRT28		Pewter
WRT29		Forest Green
WRT30		Copper Penny

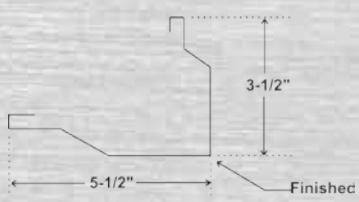

WRT60	\$00.00	Galvanized
WRT61	\$00.00	White
WRT62		Green
WRT63		Lightstone
WRT64		Taupe
WRT65		Ash Gray
WRT66		Ocean Blue
WRT67		Tan
WRT68		Charcoal Gray
WRT69		Red
WRT70		Brown
WRT71		Black
WRT72		Burgundy
WRT73		Bone White
WRT74		Antique Bronze
WRT75		Brite Red
WRT77		Dark Blue
WRT78		Pewter
WRT79		Forest Green
WRT80		Copper Penny

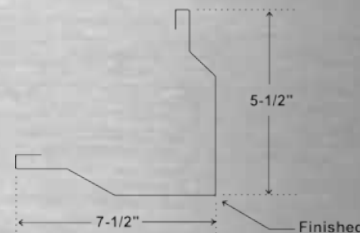

HAVE QUESTIONS? GIVE US A CALL TODAY AT 1-877-822-3530.

TRIM

10'6"		12'6"		14'3"		16'3"		7-1/2" DOOR JAM TRIM
WDJT10	\$00.00	WDJT40	\$00.00	WDJT60	\$00.00	WDJT80	\$00.00	
WDJT11	\$00.00	WDJT41	\$00.00	WDJT61	\$00.00	WDJT81	\$00.00	
WDJT12		WDJT42		WDJT62		WDJT82		
WDJT13		WDJT43		WDJT63		WDJT83		
WDJT14		WDJT44		WDJT64		WDJT84		
WDJT15		WDJT45		WDJT65		WDJT85		
WDJT16		WDJT46		WDJT66		WDJT86		
WDJT17		WDJT47		WDJT67		WDJT87		
WDJT18		WDJT48		WDJT68		WDJT88		
WDJT19		WDJT49		WDJT69		WDJT89		
WDJT20		WDJT50		WDJT70		WDJT90		
WDJT21		WDJT51		WDJT71		WDJT91		
WDJT22		WDJT52		WDJT72		WDJT92		
WDJT23		WDJT53		WDJT73		WDJT93		
WDJT24		WDJT54		WDJT74		WDJT94		
WDJT25		WDJT55		WDJT75		WDJT95		
WDJT27		WDJT57		WDJT77		WDJT97		
WDJT28		WDJT58		WDJT78		WDJT98		
WDJT29		WDJT59		WDJT79		WDJT99		
WDJT30		WDJT31		WDJT32		WDJT33		

10'6"		12'6"		14'3"		16'3"		9" DOOR JAM TRIM
WDJT210	\$00.00	WDJT240	\$00.00	WDJT260	\$00.00	WDJT280	\$00.00	
WDJT211	\$00.00	WDJT241	\$00.00	WDJT261	\$00.00	WDJT281	\$00.00	
WDJT212		WDJT242		WDJT262		WDJT282		
WDJT213		WDJT243		WDJT263		WDJT283		
WDJT214		WDJT244		WDJT264		WDJT284		
WDJT215		WDJT245		WDJT265		WDJT285		
WDJT216		WDJT246		WDJT266		WDJT286		
WDJT217		WDJT247		WDJT267		WDJT287		
WDJT218		WDJT248		WDJT268		WDJT288		
WDJT219		WDJT249		WDJT269		WDJT289		
WDJT220		WDJT250		WDJT270		WDJT290		
WDJT221		WDJT251		WDJT271		WDJT291		
WDJT222		WDJT252		WDJT272		WDJT292		
WDJT223		WDJT253		WDJT273		WDJT293		
WDJT224		WDJT254		WDJT274		WDJT294		
WDJT225		WDJT255		WDJT275		WDJT295		
WDJT227		WDJT257		WDJT277		WDJT297		
WDJT228		WDJT258		WDJT278		WDJT298		
WDJT229		WDJT259		WDJT279		WDJT299		
WDJT330		WDJT331		WDJT332		WDJT333		

10'6"		12'6"		14'3"		16'3"		7" DOOR TRIM
WDT10	\$00.00	WDT40	\$00.00	WDT60	\$00.00	WDT80	\$00.00	
WDT11	\$00.00	WDT41	\$00.00	WDT61	\$00.00	WDT81	\$00.00	
WDT12		WDT42		WDT62		WDT82		
WDT13		WDT43		WDT63		WDT83		
WDT14		WDT44		WDT64		WDT84		
WDT15		WDT45		WDT65		WDT85		
WDT16		WDT46		WDT66		WDT86		
WDT17		WDT47		WDT67		WDT87		
WDT18		WDT48		WDT68		WDT88		
WDT19		WDT49		WDT69		WDT89		
WDT20		WDT50		WDT70		WDT90		
WDT21		WDT51		WDT71		WDT91		
WDT22		WDT52		WDT72		WDT92		
WDT23		WDT53		WDT73		WDT93		
WDT24		WDT54		WDT74		WDT94		
WDT25		WDT55		WDT75		WDT95		
WDT27		WDT57		WDT77		WDT97		
WDT28		WDT58		WDT78		WDT98		
WDT29		WDT59		WDT79		WDT99		
WDT30		WDT31		WDT32		WDT33		

10'6"		12'6"		14'3"		16'3"		9" DOOR TRIM
WDT100	\$00.00	WDT140	\$00.00	WDT160	\$00.00	WDT180	\$00.00	
WDT101	\$00.00	WDT141	\$00.00	WDT161	\$00.00	WDT181	\$00.00	
WDT102		WDT142		WDT162		WDT182		
WDT103		WDT143		WDT163		WDT183		
WDT104		WDT144		WDT164		WDT184		
WDT105		WDT145		WDT165		WDT185		
WDT106		WDT146		WDT166		WDT186		
WDT107		WDT147		WDT167		WDT187		
WDT108		WDT148		WDT168		WDT188		
WDT109		WDT149		WDT169		WDT189		
WDT110		WDT150		WDT170		WDT190		
WDT111		WDT151		WDT171		WDT191		
WDT112		WDT152		WDT172		WDT192		
WDT113		WDT153		WDT173		WDT193		
WDT114		WDT154		WDT174		WDT194		
WDT115		WDT155		WDT175		WDT195		
WDT117		WDT157		WDT177		WDT197		
WDT118		WDT158		WDT178		WDT198		
WDT119		WDT159		WDT179		WDT199		
WDT330		WDT331		WDT332		WDT333		

HAVE QUESTIONS? GIVE US A CALL TODAY AT 1-877-822-3530.



FAX US YOUR ORDERS AT (701) 749-5304 OR (701) 212-4392

CROSS-SECTION

14"

20"

PRO RIDGE CAP

PWRID10	\$00.00	PWRID40	\$00.00	Galvanized/annealed
PWRID11	\$00.00	PWRID41	\$00.00	White
PWRID12	\$00.00	PWRID42	\$00.00	Green
PWRID13	\$00.00	PWRID43	\$00.00	Lightstone
PWRID14	\$00.00	PWRID44	\$00.00	Taupe
PWRID15	\$00.00	PWRID45	\$00.00	Ash Gray
PWRID16	\$00.00	PWRID46	\$00.00	Ocean Blue
PWRID17	\$00.00	PWRID47	\$00.00	Tan
PWRID18	\$00.00	PWRID48	\$00.00	Charcoal Gray
PWRID19	\$00.00	PWRID49	\$00.00	Red
PWRID20	\$00.00	PWRID50	\$00.00	Brown
PWRID21	\$00.00	PWRID51	\$00.00	Black
PWRID22	\$00.00	PWRID52	\$00.00	Burgundy
PWRID23	\$00.00	PWRID53	\$00.00	Bone White
PWRID24	\$00.00	PWRID54	\$00.00	Antique Bronze
PWRID25	\$00.00	PWRID55	\$00.00	Brite Red
PWRID27	\$00.00	PWRID57	\$00.00	Dark Blue
PWRID28	\$00.00	PWRID58	\$00.00	Pewter
PWRID29	\$00.00	PWRID59	\$00.00	Forest Green
PWRID30	\$00.00	PWRID60	\$00.00	Copper Penny

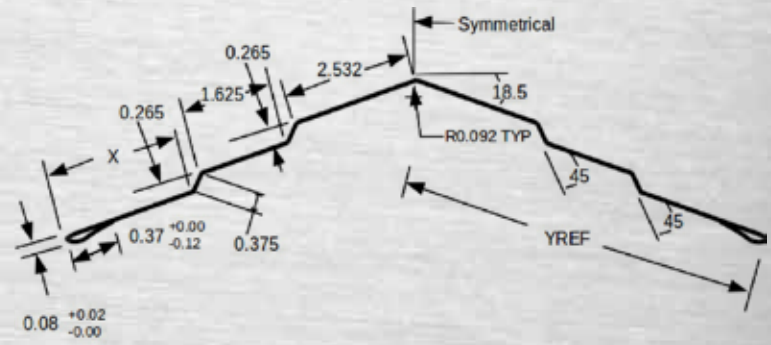

10'6"

12'6"

14'6"

16'6"

18'6"

5-1/2" X 5-1/2" PRO RIBBED RAKE & CORNER

PWRAK10	\$00.00	PWRAK40	\$00.00	PWRAK60	\$00.00	PWRAK80	\$00.00	PWRAK100	\$00.00	Galvanized
PWRAK11	\$00.00	PWRAK41	\$00.00	PWRAK61	\$00.00	PWRAK81	\$00.00	PWRAK101	\$00.00	White
PWRAK12		PWRAK42		PWRAK62		PWRAK82		PWRAK102		Green
PWRAK13		PWRAK43		PWRAK63		PWRAK83		PWRAK103		Lightstone
PWRAK14		PWRAK44		PWRAK64		PWRAK84		PWRAK104		Taupe
PWRAK15		PWRAK45		PWRAK65		PWRAK85		PWRAK105		Ash Gray
PWRAK16		PWRAK46		PWRAK66		PWRAK86		PWRAK106		Ocean Blue
PWRAK17		PWRAK47		PWRAK67		PWRAK87		PWRAK107		Tan
PWRAK18		PWRAK48		PWRAK68		PWRAK88		PWRAK108		Charcoal Gray
PWRAK19		PWRAK49		PWRAK69		PWRAK89		PWRAK109		Red
PWRAK20		PWRAK50		PWRAK70		PWRAK90		PWRAK110		Brown
PWRAK21		PWRAK51		PWRAK71		PWRAK91		PWRAK111		Black
PWRAK22		PWRAK52		PWRAK72		PWRAK92		PWRAK112		Burgundy
PWRAK23		PWRAK53		PWRAK73		PWRAK93		PWRAK113		Bone White
PWRAK24		PWRAK54		PWRAK74		PWRAK94		PWRAK114		Antique Bronze
PWRAK25		PWRAK55		PWRAK75		PWRAK95		PWRAK115		Brite Red
PWRAK27		PWRAK57		PWRAK77		PWRAK97		PWRAK117		Dark Blue
PWRAK28		PWRAK58		PWRAK78		PWRAK98		PWRAK118		Pewter
PWRAK29		PWRAK59		PWRAK79		PWRAK99		PWRAK119		Forest Green
PWRAK30		PWRAK31		PWRAK32		PWRAK33		PWRAK120		Copper Penny

10'6"

3-1/2" X 5-1/2" PRO RIBBED

PWRT10	\$00.00	Galvanized/annealed
PWRT11	\$00.00	White
PWRT12		Green
PWRT13		Lightstone
PWRT14		Taupe
PWRT15		Ash Gray
PWRT16		Ocean Blue
PWRT17		Tan
PWRT18		Charcoal Gray
PWRT19		Red
PWRT20		Brown
PWRT21		Black
PWRT22		Burgundy
PWRT23		Bone White
PWRT24		Antique Bronze
PWRT25		Brite Red
PWRT27		Dark Blue
PWRT28		Pewter
PWRT29		Forest Green
PWRT30		Copper Penny

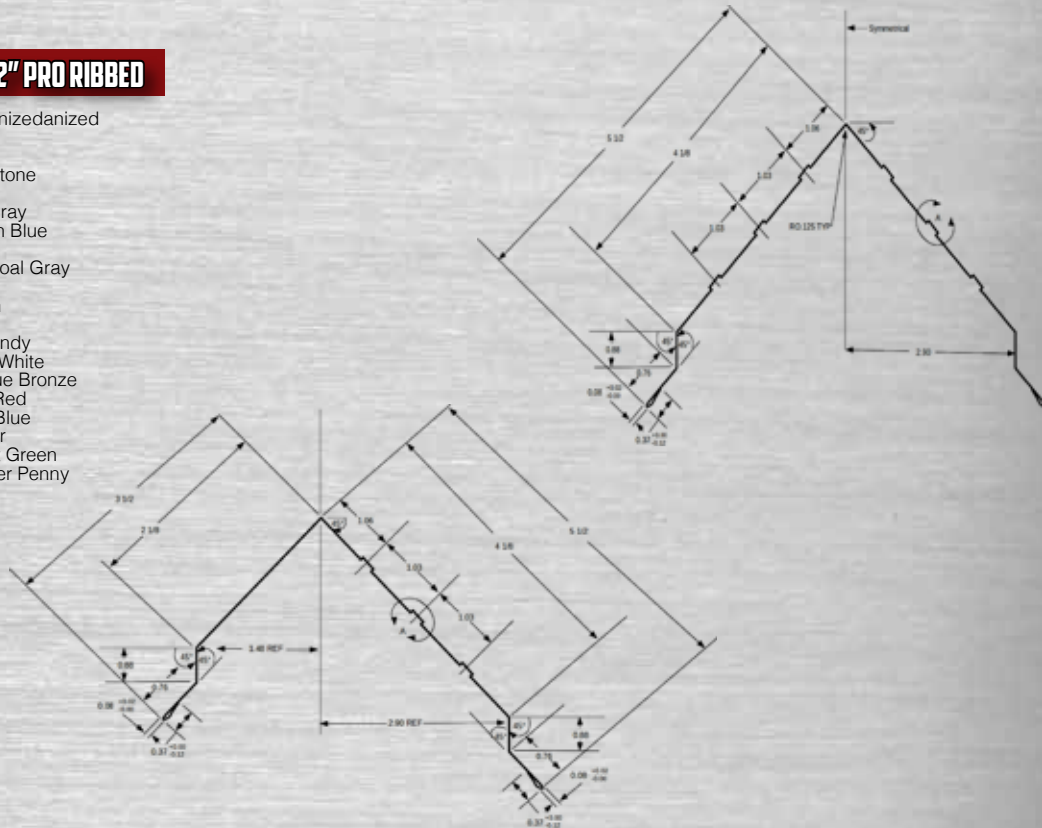

HAVE QUESTIONS? GIVE US A CALL TODAY AT 1-877-822-3530.



14"		20"		14" & 20" RIDGE CAP	
WRID10	\$00.00	WRID40	\$00.00	Galvanized	
WRID11	\$00.00	WRID41	\$00.00	White	
WRID12		WRID42		Green	
WRID13		WRID43		Lightstone	
WRID14		WRID44		Taupe	
WRID15		WRID45		Ash Gray	
WRID16		WRID46		Ocean Blue	
WRID17		WRID47		Tan	
WRID18		WRID48		Charcoal Gray	
WRID19		WRID49		Red	
WRID20		WRID50		Brown	
WRID21		WRID51		Black	
WRID22		WRID52		Burgundy	
WRID23		WRID53		Bone White	
WRID24		WRID54		Antique Bronze	
WRID25		WRID55		Brite Red	
WRID27		WRID57		Dark Blue	
WRID28		WRID58		Pewter	
WRID29		WRID59		Forest Green	
WRID30		WRID31		Copper Penny	
				WSLR16	16" Skylite Ridgecap \$00.00
				WSLR24	24" Poly Carbonated Skylite Ridgecap \$00.00

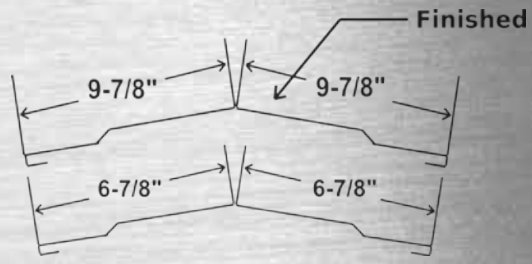

7"		9"		7" & 9" (OH) DOOR WITH DRIP	
WOH10	\$00.00	WOH40	\$00.00	Galvanized	
WOH11	\$00.00	WOH41	\$00.00	White	
WOH12		WOH42		Green	
WOH13		WOH43		Lightstone	
WOH14		WOH44		Taupe	
WOH15		WOH45		Ash Gray	
WOH16		WOH46		Ocean Blue	
WOH17		WOH47		Tan	
WOH18		WOH48		Charcoal Gray	
WOH19		WOH49		Red	
WOH20		WOH50		Brown	
WOH21		WOH51		Black	
WOH22		WOH52		Burgundy	
WOH23		WOH53		Bone White	
WOH24		WOH54		Antique Bronze	
WOH25		WOH55		Brite Red	
WOH27		WOH57		Dark Blue	
WOH28		WOH58		Pewter	
WOH29		WOH59		Forest Green	
WOH30		WOH31		Copper Penny	

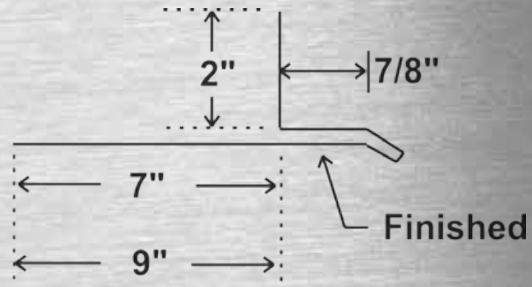

7/8" x 1/2"		7/8" x 7/8"		DOUBLE J TRIM	
WDJ10	\$00.00	WDJ40	\$00.00	Galvanized	
WDJ11	\$00.00	WDJ41	\$00.00	White	
WDJ12		WDJ42		Green	
WDJ13		WDJ43		Lightstone	
WDJ14		WDJ44		Taupe	
WDJ15		WDJ45		Ash Gray	
WDJ16		WDJ46		Ocean Blue	
WDJ17		WDJ47		Tan	
WDJ18		WDJ48		Charcoal Gray	
WDJ19		WDJ49		Red	
WDJ20		WDJ50		Brown	
WDJ21		WDJ51		Black	
WDJ22		WDJ52		Burgundy	
WDJ23		WDJ53		Bone White	
WDJ24		WDJ54		Antique Bronze	
WDJ25		WDJ55		Brite Red	
WDJ27		WDJ57		Dark Blue	
WDJ28		WDJ58		Pewter	
WDJ29		WDJ59		Forest Green	
WDJ30		WDJ31		Copper Penny	

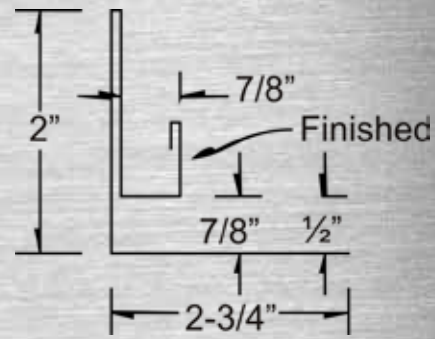

12' 6"		10' 6"		10' 6" & 12' 6" J TRIM	
WJT10	\$00.00	WJT40	\$00.00	Galvanized	
WJT11	\$00.00	WJT41	\$00.00	White	
WJT12		WJT42		Green	
WJT13		WJT43		Lightstone	
WJT14		WJT44		Taupe	
WJT15		WJT45		Ash Gray	
WJT16		WJT46		Ocean Blue	
WJT17		WJT47		Tan	
WJT18		WJT48		Charcoal Gray	
WJT19		WJT49		Red	
WJT20		WJT50		Brown	
WJT21		WJT51		Black	
WJT22		WJT52		Burgundy	
WJT23		WJT53		Bone White	
WJT24		WJT54		Antique Bronze	
WJT25		WJT55		Brite Red	
WJT27		WJT57		Dark Blue	
WJT28		WJT58		Pewter	
WJT29		WJT59		Forest Green	
WJT30		WJT31		Copper Penny	

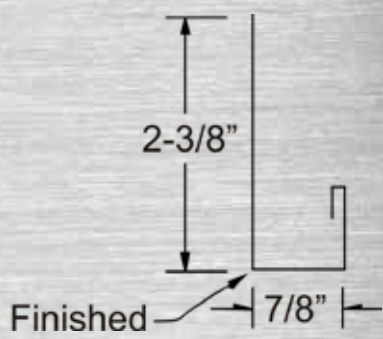

HAVE QUESTIONS? GIVE US A CALL TODAY AT 1-877-822-3530.



4" 6" 1-3/4" EAVE TRIM

WET10	\$00.00	WET40	\$00.00	WET60	\$00.00	Galvanized White Green Lightstone Taupe Ash Gray Ocean Blue Tan Charcoal Gray Red Brown Black Burgundy Bone White Antique Bronze Brite Red Dark Blue Pewter Forest Green Copper Penny
WET11	\$00.00	WET41	\$00.00	WET61	\$00.00	
WET12		WET42		WET62		
WET13		WET43		WET63		
WET14		WET44		WET64		
WET15		WET45		WET65		
WET16		WET46		WET66		
WET17		WET47		WET67		
WET18		WET48		WET68		
WET19		WET49		WET69		
WET20		WET50		WET70		
WET21		WET51		WET71		
WET22		WET52		WET72		
WET23		WET53		WET73		
WET24		WET54		WET74		
WET25		WET55		WET75		
WET27		WET57		WET77		
WET28		WET58		WET78		
WET29		WET59		WET79		
WET30		WET31		WET32		

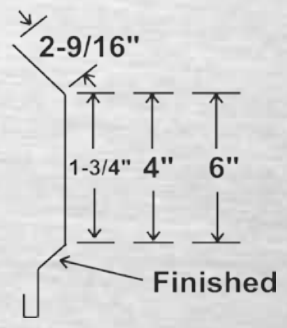

5-1/2" 7-1/2" 3-1/2" POST TRIM

WPT10	\$00.00	WPT40	\$00.00	WPT60	\$00.00	Galvanized White Green Lightstone Taupe Ash Gray Ocean Blue Tan Charcoal Gray Red Brown Black Burgundy Bone White Antique Bronze Brite Red Dark Blue Pewter Forest Green Copper Penny
WPT11	\$00.00	WPT41	\$00.00	WPT61	\$00.00	
WPT12		WPT42		WPT62		
WPT13		WPT43		WPT63		
WPT14		WPT44		WPT64		
WPT15		WPT45		WPT65		
WPT16		WPT46		WPT66		
WPT17		WPT47		WPT67		
WPT18		WPT48		WPT68		
WPT19		WPT49		WPT69		
WPT20		WPT50		WPT70		
WPT21		WPT51		WPT71		
WPT22		WPT52		WPT72		
WPT23		WPT53		WPT73		
WPT24		WPT54		WPT74		
WPT25		WPT55		WPT75		
WPT27		WPT57		WPT77		
WPT28		WPT58		WPT78		
WPT29		WPT59		WPT79		
WPT30		WPT31		WPT32		

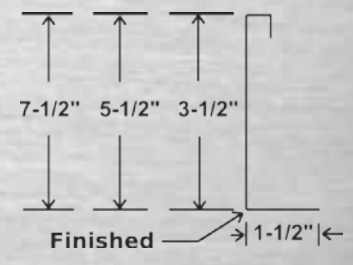

3" 2" 1-1/2" ANGLE FLASHING

WIAF10	\$00.00	WIAF40	\$00.00	WIAF60	\$00.00	Galvanized White Green Lightstone Taupe Ash Gray Ocean Blue Tan Charcoal Gray Red Brown Black Burgundy Bone White Antique Bronze Brite Red Dark Blue Pewter Forest Green Copper Penny
WIAF11	\$00.00	WIAF41	\$00.00	WIAF61	\$00.00	
WIAF12		WIAF42		WIAF62		
WIAF13		WIAF43		WIAF63		
WIAF14		WIAF44		WIAF64		
WIAF15		WIAF45		WIAF65		
WIAF16		WIAF46		WIAF66		
WIAF17		WIAF47		WIAF67		
WIAF18		WIAF48		WIAF68		
WIAF19		WIAF49		WIAF69		
WIAF20		WIAF50		WIAF70		
WIAF21		WIAF51		WIAF71		
WIAF22		WIAF52		WIAF72		
WIAF23		WIAF53		WIAF73		
WIAF24		WIAF54		WIAF74		
WIAF25		WIAF55		WIAF75		
WIAF27		WIAF57		WIAF77		
WIAF28		WIAF58		WIAF78		
WIAF29		WIAF59		WIAF79		
WIAF30		WIAF31		WIAF32		

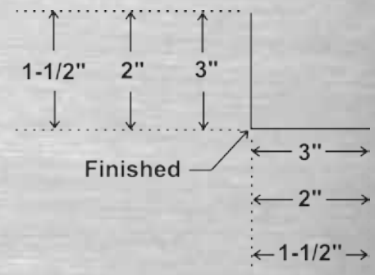

6" 8" 10" FASCIA TRIM

WFT10	\$00.00	WFT40	\$00.00	WFT60	\$00.00	Galvanized White Green Lightstone Taupe Ash Gray Ocean Blue Tan Charcoal Gray Red Brown Black Burgundy Bone White Antique Bronze Brite Red Dark Blue Pewter Forest Green Copper Penny
WFT11	\$00.00	WFT41	\$00.00	WFT61	\$00.00	
WFT12		WFT42		WFT62		
WFT13		WFT43		WFT63		
WFT14		WFT44		WFT64		
WFT15		WFT45		WFT65		
WFT16		WFT46		WFT66		
WFT17		WFT47		WFT67		
WFT18		WFT48		WFT68		
WFT19		WFT49		WFT69		
WFT20		WFT50		WFT70		
WFT21		WFT51		WFT71		
WFT22		WFT52		WFT72		
WFT23		WFT53		WFT73		
WFT24		WFT54		WFT74		
WFT25		WFT55		WFT75		
WFT27		WFT57		WFT77		
WFT28		WFT58		WFT78		
WFT29		WFT59		WFT79		
WFT30		WFT31		WFT32		

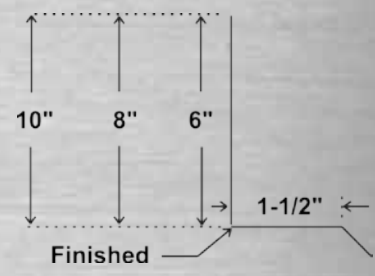

HAVE QUESTIONS? GIVE US A CALL TODAY AT 1-877-822-3530.

WALL & CEILING TRIM

WC10	\$00.00	Galvanized
WC11	\$00.00	White
WC12		Green
WC13		Lightstone
WC14		Taupe
WC15		Ash Gray
WC16		Ocean Blue
WC17		Tan
WC18		Charcoal Gray
WC19		Red
WC20		Brown
WC21		Black
WC22		Burgundy
WC23		Bone White
WC24		Antique Bronze
WC25		Brite Red
WC27		Dark Blue
WC28		Pewter
WC29		Forest Green
WC30		Copper Penny

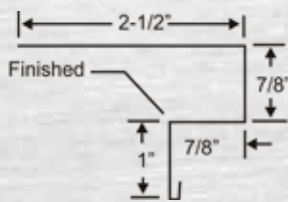

WSF10	\$00.00	Galvanized
WSF11	\$00.00	White
WSF12		Green
WSF13		Lightstone
WSF14		Taupe
WSF15		Ash Gray
WSF16		Ocean Blue
WSF17		Tan
WSF18		Charcoal Gray
WSF19		Red
WSF20		Brown
WSF21		Black
WSF22		Burgundy
WSF23		Bone White
WSF24		Antique Bronze
WSF25		Brite Red
WSF27		Dark Blue
WSF28		Pewter
WSF29		Forest Green
WSF30		Copper Penny

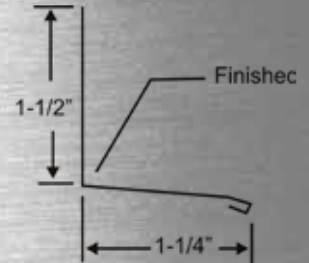

ROOF EDGE

WRE10	\$00.00	Galvanized
WRE11	\$00.00	White
WRE12		Green
WRE13		Lightstone
WRE14		Taupe
WRE15		Ash Gray
WRE16		Ocean Blue
WRE17		Tan
WRE18		Charcoal Gray
WRE19		Red
WRE20		Brown
WRE21		Black
WRE22		Burgundy
WRE23		Bone White
WRE24		Antique Bronze
WRE25		Brite Red
WRE27		Dark Blue
WRE28		Pewter
WRE29		Forest Green
WRE30		Copper Penny

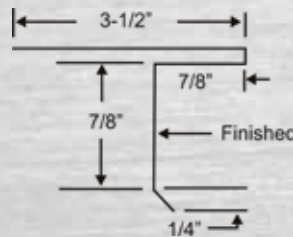

WSTS10	\$00.00	Galvanized
WSTS11	\$00.00	White
WSTS12		Green
WSTS13		Lightstone
WSTS14		Taupe
WSTS15		Ash Gray
WSTS16		Ocean Blue
WSTS17		Tan
WSTS18		Charcoal Gray
WSTS19		Red
WSTS20		Brown
WSTS21		Black
WSTS22		Burgundy
WSTS23		Bone White
WSTS24		Antique Bronze
WSTS25		Brite Red
WSTS27		Dark Blue
WSTS28		Pewter
WSTS29		Forest Green
WSTS30		Copper Penny

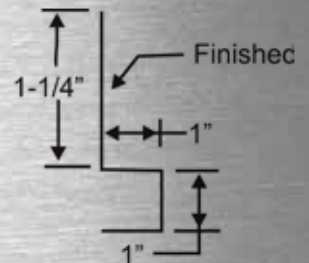

7/8\"/>

WDAT10	\$00.00	Galvanized
WDAT11	\$00.00	White
WDAT12		Green
WDAT13		Lightstone
WDAT14		Taupe
WDAT15		Ash Gray
WDAT16		Ocean Blue
WDAT17		Tan
WDAT18		Charcoal Gray
WDAT19		Red
WDAT20		Brown
WDAT21		Black
WDAT22		Burgundy
WDAT23		Bone White
WDAT24		Antique Bronze
WDAT25		Brite Red
WDAT27		Dark Blue
WDAT28		Pewter
WDAT29		Forest Green
WDAT30		Copper Penny

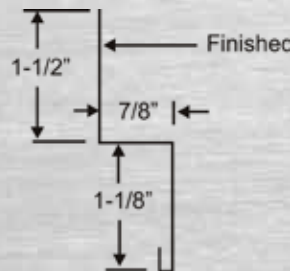

WBM10	\$00.00	Galvanized
WBM11	\$00.00	White
WBM12		Green
WBM13		Lightstone
WBM14		Taupe
WBM15		Ash Gray
WBM16		Ocean Blue
WBM17		Tan
WBM18		Charcoal Gray
WBM19		Red
WBM20		Brown
WBM21		Black
WBM22		Burgundy
WBM23		Bone White
WBM24		Antique Bronze
WBM25		Brite Red
WBM27		Dark Blue
WBM28		Pewter
WBM29		Forest Green
WBM30		Copper Penny

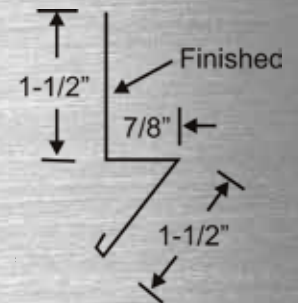

BASE MOULDING

INSIDE CORNER

WTC10	\$00.00	Galvanized
WTC11	\$00.00	White
WTC12		Green
WTC13		Lightstone
WTC14		Taupe
WTC15		Ash Gray
WTC16		Ocean Blue
WTC17		Tan
WTC18		Charcoal Gray
WTC19		Red
WTC20		Brown
WTC21		Black
WTC22		Burgundy
WTC23		Bone White
WTC24		Antique Bronze
WTC25		Brite Red
WTC27		Dark Blue
WTC28		Pewter
WTC29		Forest Green
WTC30		Copper Penny

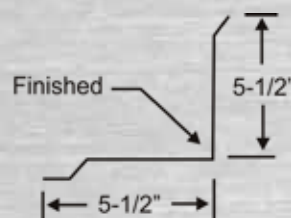

WDAT40	\$00.00	Galvanized
WDAT41	\$00.00	White
WDAT42		Green
WDAT43		Lightstone
WDAT44		Taupe
WDAT45		Ash Gray
WDAT46		Ocean Blue
WDAT47		Tan
WDAT48		Charcoal Gray
WDAT49		Red
WDAT50		Brown
WDAT51		Black
WDAT52		Burgundy
WDAT53		Bone White
WDAT54		Antique Bronze
WDAT55		Brite Red
WDAT57		Dark Blue
WDAT58		Pewter
WDAT59		Forest Green
WDAT30		Copper Penny

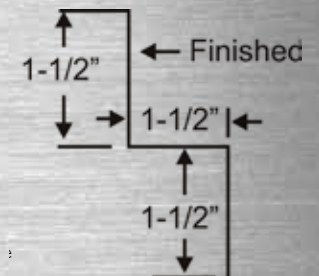

1-1/2\"/>

HAVE QUESTIONS? GIVE US A CALL TODAY AT 1-877-822-3530.



HEM FLASHING

WHF10	\$00.00
WHF11	\$00.00
WHF12	
WHF13	
WHF14	
WHF15	
WHF16	
WHF17	
WHF18	
WHF19	
WHF20	
WHF21	
WHF22	
WHF23	
WHF24	
WHF25	
WHF27	
WHF28	
WHF29	
WHF30	

Galvanized
White
Green
Lightstone
Taupe
Ash Gray
Ocean Blue
Tan
Charcoal Gray
Red
Brown
Black
Burgundy
Bone White
Antique Bronze
Brite Red
Dark Blue
Pewter
Forest Green
Copper Penny

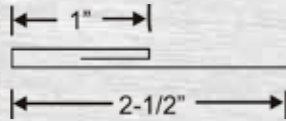

WBK10	\$00.00
WBK11	\$00.00
WBK12	
WBK13	
WBK14	
WBK15	
WBK16	
WBK17	
WBK18	
WBK19	
WBK20	
WBK21	
WBK22	
WBK23	
WBK24	
WBK25	
WBK27	
WBK28	
WBK29	
WBK30	

Galvanized
White
Green
Lightstone
Taupe
Ash Gray
Ocean Blue
Tan
Charcoal Gray
Red
Brown
Black
Burgundy
Bone White
Antique Bronze
Brite Red
Dark Blue
Pewter
Forest Green
Copper Penny

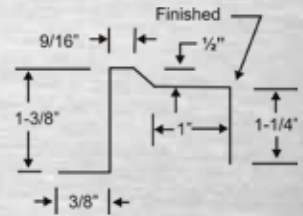

BOX END FASCIA

WBE10	\$00.00
WBE11	\$00.00
WBE12	
WBE13	
WBE14	
WBE15	
WBE16	
WBE17	
WBE18	
WBE19	
WBE20	
WBE21	
WBE22	
WBE23	
WBE24	
WBE25	
WBE27	
WBE28	
WBE29	
WBE30	

Galvanized
White
Green
Lightstone
Taupe
Ash Gray
Ocean Blue
Tan
Charcoal Gray
Red
Brown
Black
Burgundy
Bone White
Antique Bronze
Brite Red
Dark Blue
Pewter
Forest Green
Copper Penny

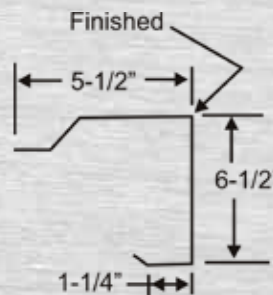

WSOF10	\$00.00
WSOF11	\$00.00
WSOF12	
WSOF13	
WSOF14	
WSOF15	
WSOF16	
WSOF17	
WSOF18	
WSOF19	
WSOF20	
WSOF21	
WSOF22	
WSOF23	
WSOF24	
WSOF25	
WSOF27	
WSOF28	
WSOF29	
WSOF30	

Galvanized
White
Green
Lightstone
Taupe
Ash Gray
Ocean Blue
Tan
Charcoal Gray
Red
Brown
Black
Burgundy
Bone White
Antique Bronze
Brite Red
Dark Blue
Pewter
Forest Green
Copper Penny

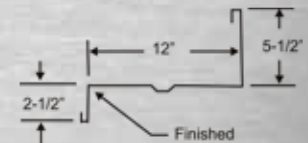

VALLEY TRIM

WVT10	\$00.00
WVT11	\$00.00
WVT12	
WVT13	
WVT14	
WVT15	
WVT16	
WVT17	
WVT18	
WVT19	
WVT20	
WVT21	
WVT22	
WVT23	
WVT24	
WVT25	
WVT27	
WVT28	
WVT29	
WVT30	

Galvanized
White
Green
Lightstone
Taupe
Ash Gray
Ocean Blue
Tan
Charcoal Gray
Red
Brown
Black
Burgundy
Bone White
Antique Bronze
Brite Red
Dark Blue
Pewter
Forest Green
Copper Penny

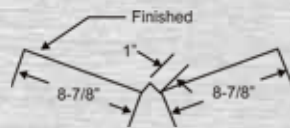

WFTR10	\$00.00
WFTR11	\$00.00
WFTR12	
WFTR13	
WFTR14	
WFTR15	
WFTR16	
WFTR17	
WFTR18	
WFTR19	
WFTR20	
WFTR21	
WFTR22	
WFTR23	
WFTR24	
WFTR25	
WFTR27	
WFTR28	
WFTR29	
WFTR30	

Galvanized
White
Green
Lightstone
Taupe
Ash Gray
Ocean Blue
Tan
Charcoal Gray
Red
Brown
Black
Burgundy
Bone White
Antique Bronze
Brite Red
Dark Blue
Pewter
Forest Green
Copper Penny

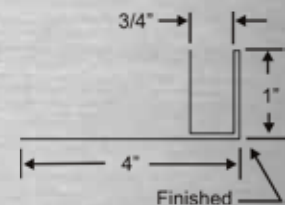

UNIVERSAL SIDEWALL

WUN10	\$00.00
WUN11	\$00.00
WUN12	
WUN13	
WUN14	
WUN15	
WUN16	
WUN17	
WUN18	
WUN19	
WUN20	
WUN21	
WUN22	
WUN23	
WUN24	
WUN25	
WUN27	
WUN28	
WUN29	
WUN30	

Galvanized
White
Green
Lightstone
Taupe
Ash Gray
Ocean Blue
Tan
Charcoal Gray
Red
Brown
Black
Burgundy
Bone White
Antique Bronze
Brite Red
Dark Blue
Pewter
Forest Green
Copper Penny

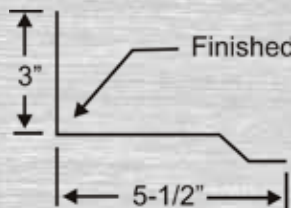

WRGT40	\$00.00
WRGT41	\$00.00
WRGT42	
WRGT43	
WRGT44	
WRGT45	
WRGT46	
WRGT47	
WRGT48	
WRGT49	
WRGT50	
WRGT51	
WRGT52	
WRGT53	
WRGT54	
WRGT55	
WRGT57	
WRGT58	
WRGT59	
WRGT30	

Galvanized
White
Green
Lightstone
Taupe
Ash Gray
Ocean Blue
Tan
Charcoal Gray
Red
Brown
Black
Burgundy
Bone White
Antique Bronze
Brite Red
Dark Blue
Pewter
Forest Green
Copper Penny

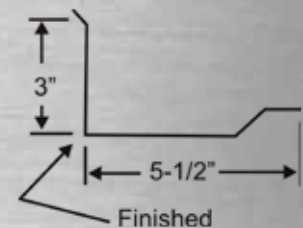

HAVE QUESTIONS? GIVE US A CALL TODAY AT 1-877-822-3530.



CLASSIC RAKE

WCR10	\$00.00
WCR11	\$00.00
WCR12	
WCR13	
WCR14	
WCR15	
WCR16	
WCR17	
WCR18	
WCR19	
WCR20	
WCR21	
WCR22	
WCR23	
WCR24	
WCR25	
WCR27	
WCR28	
WCR29	
WCR30	

Galvanized
White
Green
Lightstone
Taupe
Ash Gray
Ocean Blue
Tan
Charcoal Gray
Red
Brown
Black
Burgundy
Bone White
Antique Bronze
Brite Red
Dark Blue
Pewter
Forest Green
Copper Penny

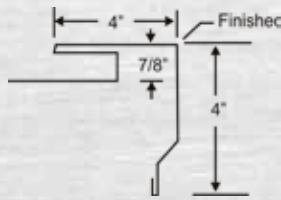

WCL10	\$00.00
WCL11	\$00.00
WCL12	
WCL13	
WCL14	
WCL15	
WCL16	
WCL17	
WCL18	
WCL19	
WCL20	
WCL21	
WCL22	
WCL23	
WCL24	
WCL25	
WCL27	
WCL28	
WCL29	
WCL30	

Galvanized
White
Green
Lightstone
Taupe
Ash Gray
Ocean Blue
Tan
Charcoal Gray
Red
Brown
Black
Burgundy
Bone White
Antique Bronze
Brite Red
Dark Blue
Pewter
Forest Green
Copper Penny

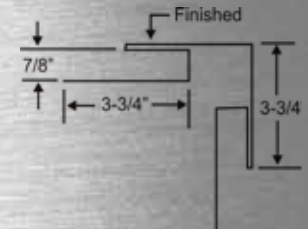

HIP RIDGE CAP

WHR10	\$00.00
WHR11	\$00.00
WHR12	
WHR13	
WHR14	
WHR15	
WHR16	
WHR17	
WHR18	
WHR19	
WHR20	
WHR21	
WHR22	
WHR23	
WHR24	
WHR25	
WHR27	
WHR28	
WHR29	
WHR30	

Galvanized
White
Green
Lightstone
Taupe
Ash Gray
Ocean Blue
Tan
Charcoal Gray
Red
Brown
Black
Burgundy
Bone White
Antique Bronze
Brite Red
Dark Blue
Pewter
Forest Green
Copper Penny

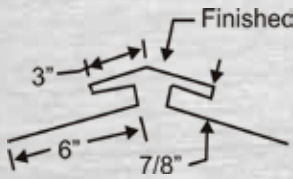

WSV10	\$00.00
WSV11	\$00.00
WSV12	
WSV13	
WSV14	
WSV15	
WSV16	
WSV17	
WSV18	
WSV19	
WSV20	
WSV21	
WSV22	
WSV23	
WSV24	
WSV25	
WSV27	
WSV28	
WSV29	
WSV30	

Galvanized
White
Green
Lightstone
Taupe
Ash Gray
Ocean Blue
Tan
Charcoal Gray
Red
Brown
Black
Burgundy
Bone White
Antique Bronze
Brite Red
Dark Blue
Pewter
Forest Green
Copper Penny

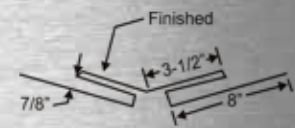

PEAK CAP

WPC10	\$00.00
WPC11	\$00.00
WPC12	
WPC13	
WPC14	
WPC15	
WPC16	
WPC17	
WPC18	
WPC19	
WPC20	
WPC21	
WPC22	
WPC23	
WPC24	
WPC25	
WPC27	
WPC28	
WPC29	
WPC30	

Galvanized
White
Green
Lightstone
Taupe
Ash Gray
Ocean Blue
Tan
Charcoal Gray
Red
Brown
Black
Burgundy
Bone White
Antique Bronze
Brite Red
Dark Blue
Pewter
Forest Green
Copper Penny

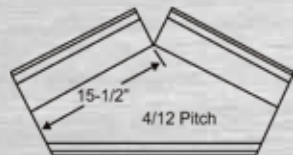

WRR10	\$00.00
WRR11	\$00.00
WRR12	
WRR13	
WRR14	
WRR15	
WRR16	
WRR17	
WRR18	
WRR19	
WRR20	
WRR21	
WRR22	
WRR23	
WRR24	
WRR25	
WRR27	
WRR28	
WRR29	
WRR30	

Galvanized
White
Green
Lightstone
Taupe
Ash Gray
Ocean Blue
Tan
Charcoal Gray
Red
Brown
Black
Burgundy
Bone White
Antique Bronze
Brite Red
Dark Blue
Pewter
Forest Green
Copper Penny

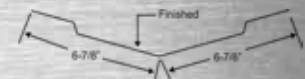

ASTRAGAL TRIM

WAT10	\$00.00
WAT11	\$00.00
WAT12	
WAT13	
WAT14	
WAT15	
WAT16	
WAT17	
WAT18	
WAT19	
WAT20	
WAT21	
WAT22	
WAT23	
WAT24	
WAT25	
WAT27	
WAT28	
WAT29	
WAT30	

Galvanized
White
Green
Lightstone
Taupe
Ash Gray
Ocean Blue
Tan
Charcoal Gray
Red
Brown
Black
Burgundy
Bone White
Antique Bronze
Brite Red
Dark Blue
Pewter
Forest Green
Copper Penny

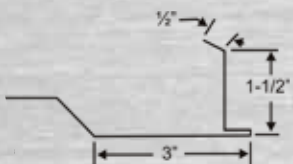

WEG10	\$00.00
WEG11	\$00.00
WEG12	
WEG13	
WEG14	
WEG15	
WEG16	
WEG17	
WEG18	
WEG19	
WEG20	
WEG21	
WEG22	
WEG23	
WEG24	
WEG25	
WEG27	
WEG28	
WEG29	
WEG30	

Galvanized
White
Green
Lightstone
Taupe
Ash Gray
Ocean Blue
Tan
Charcoal Gray
Red
Brown
Black
Burgundy
Bone White
Antique Bronze
Brite Red
Dark Blue
Pewter
Forest Green
Copper Penny

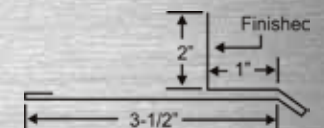

HAVE QUESTIONS? GIVE US A CALL TODAY AT 1-877-822-3530.



TRACK BOARD COVER

WTB10	\$00.00	Galvanized
WTB11	\$00.00	White
WTB12		Green
WTB13		Lightstone
WTB14		Taupe
WTB15		Ash Gray
WTB16		Ocean Blue
WTB17		Tan
WTB18		Charcoal Gray
WTB19		Red
WTB20		Brown
WTB21		Black
WTB22		Burgundy
WTB23		Bone White
WTB24		Antique Bronze
WTB25		Brite Red
WTB27		Dark Blue
WTB28		Pewter
WTB29		Forest Green
WTB30		Copper Penny

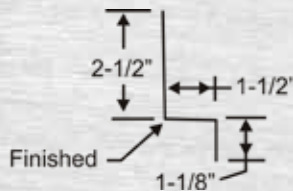

ENDWALL SIDEWALL

WES10	\$00.00	Galvanized
WES11	\$00.00	White
WES12		Green
WES13		Lightstone
WES14		Taupe
WES15		Ash Gray
WES16		Ocean Blue
WES17		Tan
WES18		Charcoal Gray
WES19		Red
WES20		Brown
WES21		Black
WES22		Burgundy
WES23		Bone White
WES24		Antique Bronze
WES25		Brite Red
WES27		Dark Blue
WES28		Pewter
WES29		Forest Green
WES30		Copper Penny

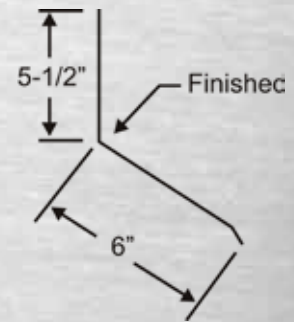

TRACK COVER

WTC10	\$00.00	Galvanized
WTC11	\$00.00	White
WTC12		Green
WTC13		Lightstone
WTC14		Taupe
WTC15		Ash Gray
WTC16		Ocean Blue
WTC17		Tan
WTC18		Charcoal Gray
WTC19		Red
WTC20		Brown
WTC21		Black
WTC22		Burgundy
WTC23		Bone White
WTC24		Antique Bronze
WTC25		Brite Red
WTC27		Dark Blue
WTC28		Pewter
WTC29		Forest Green
WTC30		Copper Penny

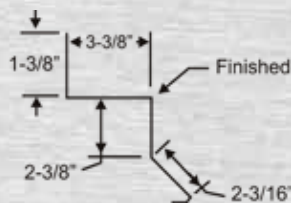

GUTTER APRON

WGA10	\$00.00	Galvanized
WGA11	\$00.00	White
WGA12		Green
WGA13		Lightstone
WGA14		Taupe
WGA15		Ash Gray
WGA16		Ocean Blue
WGA17		Tan
WGA18		Charcoal Gray
WGA19		Red
WGA20		Brown
WGA21		Black
WGA22		Burgundy
WGA23		Bone White
WGA24		Antique Bronze
WGA25		Brite Red
WGA27		Dark Blue
WGA28		Pewter
WGA29		Forest Green
WGA30		Copper Penny

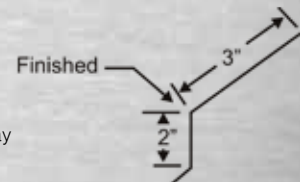

DOOR HEADER

WDH10	\$00.00	Galvanized
WDH11	\$00.00	White
WDH12		Green
WDH13		Lightstone
WDH14		Taupe
WDH15		Ash Gray
WDH16		Ocean Blue
WDH17		Tan
WDH18		Charcoal Gray
WDH19		Red
WDH20		Brown
WDH21		Black
WDH22		Burgundy
WDH23		Bone White
WDH24		Antique Bronze
WDH25		Brite Red
WDH27		Dark Blue
WDH28		Pewter
WDH29		Forest Green
WDH30		Copper Penny

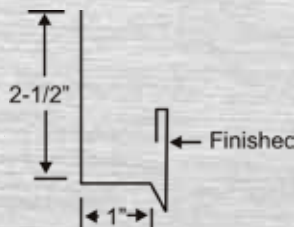

DRIP CAP

WDC10	\$00.00	Galvanized
WDC11	\$00.00	White
WDC12		Green
WDC13		Lightstone
WDC14		Taupe
WDC15		Ash Gray
WDC16		Ocean Blue
WDC17		Tan
WDC18		Charcoal Gray
WDC19		Red
WDC20		Brown
WDC21		Black
WDC22		Burgundy
WDC23		Bone White
WDC24		Antique Bronze
WDC25		Brite Red
WDC27		Dark Blue
WDC28		Pewter
WDC29		Forest Green
WDC30		Copper Penny

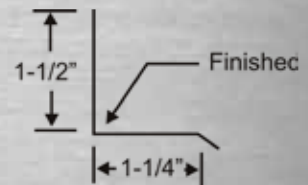

BULL NOSE TRIM

WBC10	\$00.00	Galvanized
WBC11	\$00.00	White
WBC12		Green
WBC13		Lightstone
WBC14		Taupe
WBC15		Ash Gray
WBC16		Ocean Blue
WBC17		Tan
WBC18		Charcoal Gray
WBC19		Red
WBC20		Brown
WBC21		Black
WBC22		Burgundy
WBC23		Bone White
WBC24		Antique Bronze
WBC25		Brite Red
WBC27		Dark Blue
WBC28		Pewter
WBC29		Forest Green
WBC30		Copper Penny

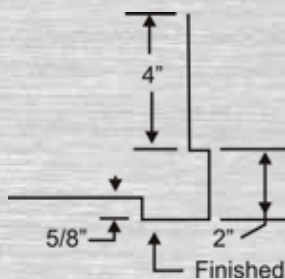

SNOW GUARD

WSG10	\$00.00	Galvanized
WSG11	\$00.00	White
WSG12		Green
WSG13		Lightstone
WSG14		Taupe
WSG15		Ash Gray
WSG16		Ocean Blue
WSG17		Tan
WSG18		Charcoal Gray
WSG19		Red
WSG20		Brown
WSG21		Black
WSG22		Burgundy
WSG23		Bone White
WSG24		Antique Bronze
WSG25		Brite Red
WSG27		Dark Blue
WSG28		Pewter
WSG29		Forest Green
WSG30		Copper Penny

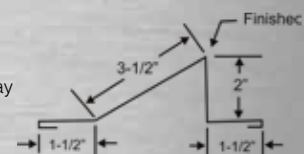

HAVE QUESTIONS? GIVE US A CALL TODAY AT 1-877-822-3530.



SCREWS

Item #	Count	Size	METAL TO WOOD SCREWS	
WSCR10	250/Bag	#10 x 1"	Galvanized	\$0.00
WSCR11	250/Bag	#10 x 1"	White	\$0.00
WSCR12	250/Bag	#10 x 1"	Green	\$0.00
WSCR13	250/Bag	#10 x 1"	Lightstone	\$0.00
WSCR14	250/Bag	#10 x 1"	Taupe	\$0.00
WSCR15	250/Bag	#10 x 1"	Ash Gray	\$0.00
WSCR16	250/Bag	#10 x 1"	Ocean Blue	\$0.00
WSCR17	250/Bag	#10 x 1"	Tan	\$0.00
WSCR18	250/Bag	#10 x 1"	Charcoal Gray	\$0.00
WSCR19	250/Bag	#10 x 1"	Red	\$0.00
WSCR20	250/Bag	#10 x 1"	Brown	\$0.00
WSCR21	250/Bag	#10 x 1"	Black	\$0.00
WSCR22	250/Bag	#10 x 1"	Burgundy	\$0.00
WSCR23	250/Bag	#10 x 1"	Bone White	\$0.00
WSCR24	250/Bag	#10 x 1"	Antique Bronze	\$0.00
WSCR25	250/Bag	#10 x 1"	Brite Red	\$0.00
WSCR27	250/Bag	#10 x 1"	Dark Blue	\$0.00
WSCR28	250/Bag	#10 x 1"	Pewter	\$0.00
WSCR29	250/Bag	#10 x 1"	Forest Green	\$0.00
WSCR30	250/Bag	#10 x 1"	Copper Penny	\$0.00

Item #	Count	Size	METAL TO WOOD SCREWS	
WSCR100	250/Bag	#10 x 3"	Galvanized	\$00.00
WSCR101	250/Bag	#10 x 3"	White	\$00.00
WSCR102	250/Bag	#10 x 3"	Green	\$00.00
WSCR103	250/Bag	#10 x 3"	Lightstone	\$00.00
WSCR104	250/Bag	#10 x 3"	Taupe	\$00.00
WSCR105	250/Bag	#10 x 3"	Ash Gray	\$00.00
WSCR106	250/Bag	#10 x 3"	Ocean Blue	\$00.00
WSCR107	250/Bag	#10 x 3"	Tan	\$00.00
WSCR108	250/Bag	#10 x 3"	Charcoal Gray	\$00.00
WSCR109	250/Bag	#10 x 3"	Red	\$00.00
WSCR110	250/Bag	#10 x 3"	Brown	\$00.00
WSCR111	250/Bag	#10 x 3"	Black	\$00.00
WSCR112	250/Bag	#10 x 3"	Burgundy	\$00.00
WSCR113	250/Bag	#10 x 3"	Bone White	\$00.00
WSCR114	250/Bag	#10 x 3"	Antique Bronze	\$00.00
WSCR115	250/Bag	#10 x 3"	Brite Red	\$00.00
WSCR117	250/Bag	#10 x 3"	Dark Blue	\$00.00
WSCR118	250/Bag	#10 x 3"	Pewter	\$00.00
WSCR119	250/Bag	#10 x 3"	Forest Green	\$00.00
WSCR120	250/Bag	#10 x 3"	Copper Penny	\$00.00

Item #	Count	Size	METAL TO WOOD SCREWS	
WSCR40	250/Bag	#10 x 1-1/2"	Galvanized	\$0.00
WSCR41	250/Bag	#10 x 1-1/2"	White	\$0.00
WSCR42	250/Bag	#10 x 1-1/2"	Green	\$0.00
WSCR43	250/Bag	#10 x 1-1/2"	Lightstone	\$0.00
WSCR44	250/Bag	#10 x 1-1/2"	Taupe	\$0.00
WSCR45	250/Bag	#10 x 1-1/2"	Ash Gray	\$0.00
WSCR46	250/Bag	#10 x 1-1/2"	Ocean Blue	\$0.00
WSCR47	250/Bag	#10 x 1-1/2"	Tan	\$0.00
WSCR48	250/Bag	#10 x 1-1/2"	Charcoal Gray	\$0.00
WSCR49	250/Bag	#10 x 1-1/2"	Red	\$0.00
WSCR50	250/Bag	#10 x 1-1/2"	Brown	\$0.00
WSCR51	250/Bag	#10 x 1-1/2"	Black	\$0.00
WSCR52	250/Bag	#10 x 1-1/2"	Burgundy	\$0.00
WSCR53	250/Bag	#10 x 1-1/2"	Bone White	\$0.00
WSCR54	250/Bag	#10 x 1-1/2"	Antique Bronze	\$0.00
WSCR55	250/Bag	#10 x 1-1/2"	Brite Red	\$0.00
WSCR57	250/Bag	#10 x 1-1/2"	Dark Blue	\$0.00
WSCR58	250/Bag	#10 x 1-1/2"	Pewter	\$0.00
WSCR59	250/Bag	#10 x 1-1/2"	Forest Green	\$0.00
WSCR31	250/Bag	#10 x 1-1/2"	Copper Penny	\$0.00

Item #	Count	Size	METAL TO WOOD SCREWS	
WSCR120	250/Bag	#10 x 3-1/2"	Galvanized	\$00.00
WSCR121	250/Bag	#10 x 3-1/2"	White	\$00.00
WSCR140	250/Bag	#10 x 4"	Galvanized	\$00.00
WSCR141	250/Bag	#10 x 4"	White	\$00.00



Item #	Count	Size	METAL TO WOOD SCREWS	
WSCR60	250/Bag	#10 x 2"	Galvanized	\$00.00
WSCR61	250/Bag	#10 x 2"	White	\$00.00
WSCR62	250/Bag	#10 x 2"	Green	\$00.00
WSCR63	250/Bag	#10 x 2"	Lightstone	\$00.00
WSCR64	250/Bag	#10 x 2"	Taupe	\$00.00
WSCR65	250/Bag	#10 x 2"	Ash Gray	\$00.00
WSCR66	250/Bag	#10 x 2"	Ocean Blue	\$00.00
WSCR67	250/Bag	#10 x 2"	Tan	\$00.00
WSCR68	250/Bag	#10 x 2"	Charcoal Gray	\$00.00
WSCR69	250/Bag	#10 x 2"	Red	\$00.00
WSCR70	250/Bag	#10 x 2"	Brown	\$00.00
WSCR71	250/Bag	#10 x 2"	Black	\$00.00
WSCR72	250/Bag	#10 x 2"	Burgundy	\$00.00
WSCR73	250/Bag	#10 x 2"	Bone White	\$00.00
WSCR74	250/Bag	#10 x 2"	Antique Bronze	\$00.00
WSCR75	250/Bag	#10 x 2"	Brite Red	\$00.00
WSCR77	250/Bag	#10 x 2"	Dark Blue	\$00.00
WSCR78	250/Bag	#10 x 2"	Pewter	\$00.00
WSCR79	250/Bag	#10 x 2"	Forest Green	\$00.00
WSCR32	250/Bag	#10 x 2"	Copper Penny	\$00.00

Item #	Count	Size	TORQUE DRIVE LO-PROFILE WOOD SCREW	
WLP11	250/Bag	#9 x 1-1/2"	Galvanized	\$00.00
WLP12	250/Bag	#9 x 1-1/2"	White	\$00.00
WLP13	250/Bag	#9 x 1-1/2"	Green	\$00.00
WLP14	250/Bag	#9 x 1-1/2"	Lightstone	\$00.00
WLP15	250/Bag	#9 x 1-1/2"	Taupe	\$00.00
WLP16	250/Bag	#9 x 1-1/2"	Ash Gray	\$00.00
WLP17	250/Bag	#9 x 1-1/2"	Ocean Blue	\$00.00
WLP18	250/Bag	#9 x 1-1/2"	Tan	\$00.00
WLP19	250/Bag	#9 x 1-1/2"	Charcoal Gray	\$00.00
WLP20	250/Bag	#9 x 1-1/2"	Red	\$00.00
WLP21	250/Bag	#9 x 1-1/2"	Brown	\$00.00
WLP22	250/Bag	#9 x 1-1/2"	Black	\$00.00
WLP23	250/Bag	#9 x 1-1/2"	Burgundy	\$00.00
WLP24	250/Bag	#9 x 1-1/2"	Bone White	\$00.00
WLP25	250/Bag	#9 x 1-1/2"	Antique Bronze	\$00.00
WLP26	250/Bag	#9 x 1-1/2"	Brite Red	\$00.00
WLP27	250/Bag	#9 x 1-1/2"	Dark Blue	\$00.00
WLP28	250/Bag	#9 x 1-1/2"	Pewter	\$00.00
WLP29	250/Bag	#9 x 1-1/2"	Forest Green	\$00.00
WLP30	250/Bag	#9 x 1-1/2"	Copper Penny	\$00.00

Item #	Count	Size	METAL TO WOOD SCREWS	
WSCR80	250/Bag	#10 x 2-1/2"	Galvanized	\$00.00
WSCR81	250/Bag	#10 x 2-1/2"	White	\$00.00
WSCR82	250/Bag	#10 x 2-1/2"	Green	\$00.00
WSCR83	250/Bag	#10 x 2-1/2"	Lightstone	\$00.00
WSCR84	250/Bag	#10 x 2-1/2"	Taupe	\$00.00
WSCR85	250/Bag	#10 x 2-1/2"	Ash Gray	\$00.00
WSCR86	250/Bag	#10 x 2-1/2"	Ocean Blue	\$00.00
WSCR87	250/Bag	#10 x 2-1/2"	Tan	\$00.00
WSCR88	250/Bag	#10 x 2-1/2"	Charcoal Gray	\$00.00
WSCR89	250/Bag	#10 x 2-1/2"	Red	\$00.00
WSCR90	250/Bag	#10 x 2-1/2"	Brown	\$00.00
WSCR91	250/Bag	#10 x 2-1/2"	Black	\$00.00
WSCR92	250/Bag	#10 x 2-1/2"	Burgundy	\$00.00
WSCR93	250/Bag	#10 x 2-1/2"	Bone White	\$00.00
WSCR94	250/Bag	#10 x 2-1/2"	Antique Bronze	\$00.00
WSCR95	250/Bag	#10 x 2-1/2"	Brite Red	\$00.00
WSCR97	250/Bag	#10 x 2-1/2"	Dark Blue	\$00.00
WSCR98	250/Bag	#10 x 2-1/2"	Pewter	\$00.00
WSCR99	250/Bag	#10 x 2-1/2"	Forest Green	\$00.00
WSCR33	250/Bag	#10 x 2-1/2"	Copper Penny	\$00.00

Item #	Count	Size	METAL TO WOOD STAINLESS STEEL SCREWS	
WSCR201	250/Bag	#9 x 1"	Stainless Steel	\$00.00
WSCR202	250/Bag	#9 x 1-1/2"	Stainless Steel	\$00.00
WSCR203	250/Bag	#9 x 2"	Stainless Steel	\$00.00
WSCR205	250/Bag	#10 x 3"	Stainless Steel	\$00.00
WNS1	1/4"	Nutsetter		\$00.00
WNS2	5/16"	Nutsetter		\$00.00
WNS3	3/8"	Nutsetter		\$00.00



HAVE QUESTIONS? GIVE US A CALL TODAY AT 1-877-822-3530.

FAX US YOUR ORDERS AT (701) 749-5304 OR (701) 212-4392



SCREWS

Item #	Count	Size	SELF DRILLERS	
SD10	250/Bag	#12 x 1"	Galvanized	\$00.00
SD11	250/Bag	#12 x 1"	White	\$00.00
SD12	250/Bag	#12 x 1"	Green	\$00.00
SD13	250/Bag	#12 x 1"	Lightstone	\$00.00
SD14	250/Bag	#12 x 1"	Taupe	\$00.00
SD15	250/Bag	#12 x 1"	Ash Gray	\$00.00
SD16	250/Bag	#12 x 1"	Ocean Blue	\$00.00
SD17	250/Bag	#12 x 1"	Tan	\$00.00
SD18	250/Bag	#12 x 1"	Charcoal Gray	\$00.00
SD19	250/Bag	#12 x 1"	Red	\$00.00
SD20	250/Bag	#12 x 1"	Brown	\$00.00
SD21	250/Bag	#12 x 1"	Black	\$00.00
SD22	250/Bag	#12 x 1"	Burgundy	\$00.00
SD23	250/Bag	#12 x 1"	Bone White	\$00.00
SD24	250/Bag	#12 x 1"	Antique Bronze	\$00.00
SD25	250/Bag	#12 x 1"	Brite Red	\$00.00
SD27	250/Bag	#12 x 1"	Dark Blue	\$00.00
SD28	250/Bag	#12 x 1"	Pewter	\$00.00
SD29	250/Bag	#12 x 1"	Forest Green	\$00.00
SD30	250/Bag	#12 x 1"	Copper Penny	\$00.00

Item #	Count	Size	STAINLESS SELF DRILLERS	
SD108	250/Bag	# 12 x 3/4"	Galvanized	\$00.00
SD141	250/Bag	# 12 x 1-1/4"	White	\$00.00

Item #	Count	Size	SELF DRILLERS	
MD8	25-/Bag	# 12 x 3/4"	White	\$00.00
MD6	250/Bag	# 12 x 12-1"	White, No Washer	\$00.00
MD4	250/Bag	# 12 x 3/4"	White, No Washer	\$00.00

Item #	Count	Size	SELF DRILLERS	
SD40	250/Bag	#12 x 1-1/2"	Galvanized	\$00.00
SD41	250/Bag	#12 x 1-1/2"	White	\$00.00
SD42	250/Bag	#12 x 1-1/2"	Green	\$00.00
SD43	250/Bag	#12 x 1-1/2"	Lightstone	\$00.00
SD44	250/Bag	#12 x 1-1/2"	Taupe	\$00.00
SD45	250/Bag	#12 x 1-1/2"	Ash Gray	\$00.00
SD46	250/Bag	#12 x 1-1/2"	Ocean Blue	\$00.00
SD47	250/Bag	#12 x 1-1/2"	Tan	\$00.00
SD48	250/Bag	#12 x 1-1/2"	Charcoal Gray	\$00.00
SD49	250/Bag	#12 x 1-1/2"	Red	\$00.00
SD50	250/Bag	#12 x 1-1/2"	Brown	\$00.00
SD51	250/Bag	#12 x 1-1/2"	Black	\$00.00
SD52	250/Bag	#12 x 1-1/2"	Burgundy	\$00.00
SD53	250/Bag	#12 x 1-1/2"	Bone White	\$00.00
SD54	250/Bag	#12 x 1-1/2"	Antique Bronze	\$00.00
SD55	250/Bag	#12 x 1-1/2"	Brite Red	\$00.00
SD57	250/Bag	#12 x 1-1/2"	Dark Blue	\$00.00
SD58	250/Bag	#12 x 1-1/2"	Pewter	\$00.00
SD59	250/Bag	#12 x 1-1/2"	Forest Green	\$00.00
SD31	250/Bag	#12 x 1-1/2"	Copper Penny	\$00.00

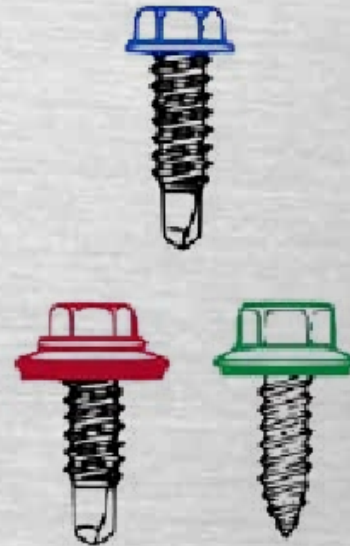













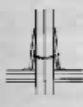

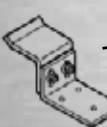
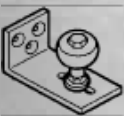
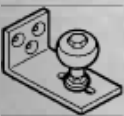
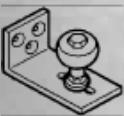
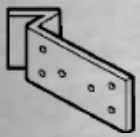
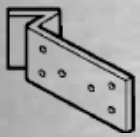
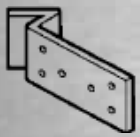
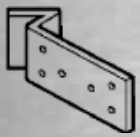
Item #	Count	Size	LAB STITCH SCREWS	
LS10	250/Bag	#12 x 3/4" Stitch	Galvanized	\$00.00
LS11	250/Bag	#12 x 3/4" Stitch	White	\$00.00
LS12	250/Bag	#12 x 3/4" Stitch	Green	\$00.00
LS13	250/Bag	#12 x 3/4" Stitch	Lightstone	\$00.00
LS14	250/Bag	#12 x 3/4" Stitch	Taupe	\$00.00
LS15	250/Bag	#12 x 3/4" Stitch	Ash Gray	\$00.00
LS16	250/Bag	#12 x 3/4" Stitch	Ocean Blue	\$00.00
LS17	250/Bag	#12 x 3/4" Stitch	Tan	\$00.00
LS18	250/Bag	#12 x 3/4" Stitch	Charcoal Gray	\$00.00
LS19	250/Bag	#12 x 3/4" Stitch	Red	\$00.00
LS20	250/Bag	#12 x 3/4" Stitch	Brown	\$00.00
LS21	250/Bag	#12 x 3/4" Stitch	Black	\$00.00
LS22	250/Bag	#12 x 3/4" Stitch	Burgundy	\$00.00
LS23	250/Bag	#12 x 3/4" Stitch	Bone White	\$00.00
LS24	250/Bag	#12 x 3/4" Stitch	Antique Bronze	\$00.00
LS25	250/Bag	#12 x 3/4" Stitch	Brite Red	\$00.00
LS27	250/Bag	#12 x 3/4" Stitch	Dark Blue	\$00.00
LS28	250/Bag	#12 x 3/4" Stitch	Pewter	\$00.00
LS29	250/Bag	#12 x 3/4" Stitch	Forest Green	\$00.00
LS30	250/Bag	#12 x 3/4" Stitch	Copper Penny	\$00.00

Item #	Count	Size	SELF DRILLERS	
WMD61	250/Bag	# 12 x 2"	White	\$00.00
WMD80	250/Bag	# 12 x 1-1/2"	Galvanized	\$00.00
WMD81	250-/Bag	# 24 x 1-1/2"	White	\$00.00
WNS1	1/4"	Nutsetter		\$0.00
WNS2	5/16"	Nutsetter		\$0.00
WNS3	3/8"	Nutsetter		\$0.00



HAVE QUESTIONS? GIVE US A CALL TODAY AT 1-877-822-3530.



	WSQT	9.5 Adj - Trolley f/sq.	\$00.00
	WJL7	2 0 Adj. 7" Jamb Latches	\$00.00
	WDSN	Wood Frame Door Snugger	\$00.00
	WDPG	Jumbo Zinc Door Pull	\$0.00
	WDPW	Jumbo White Door Pull	\$0.00
	WDST	Heavy Duty Door Stop	\$0.00
	WADJ	Adjust-A-Stop White	\$00.00
	WSTR	Offset - Adj. Stay Roller	\$00.00
	WSTM	Stop Jamb Mount	\$0.00
	WFL3	# 3 Flasher 1/4" to 5"	\$00.00
	WFL5	# 5 Flasher 4-1/2" to 7-1/2"	\$00.00
	WFL8	# 8 Flasher 7" to 13"	\$00.00
	WFL9	# 9 Flasher 10" to 19"	\$00.00
	WFL44	# 4 Hi-Temp - 100° to 450° 1/4" to 5"	\$00.00
	WFL6	# 6 Hi-Temp - 100° to 450° 4" to 7"	\$00.00
	WFL10	# 10 Hi-Temp 100° to 450° 7" to 13"	\$000.00
	WFL12	# 12 Hi-Temp - 100° to 450° 10" to 19"	\$000.00
	WDL10	Stainless Steel Door Lock	\$00.00
	WDL12	Heavy Duty Stainless Steel Door Lock	\$00.00
	WDL16	Entrance Lever Lock	\$00.00
	WDL22	Heavy Duty Entrance Lever Lock	\$00.00
	WDL24	2-3/4" Dead Bolt	\$00.00

HAVE QUESTIONS? GIVE US A CALL TODAY AT 1-877-822-3530.



DOORS

Item #	3/0 x 6/8 Actual Unit Size 38-5/8" x 80-5/8"	Price
WD110	AS3 Walk Door 3/0 x 6/8	\$000.00
WD20	AS3 Walk Door 3/0 x 6/8 RH 22" x 36" 1-Lite	\$000.00
WD40	AS3 Walk Door 3/0 x 6/8 LH 22" x 36" 1-Lite	\$000.00

Item #	4/0 x 6/8 Actual Unit Size 49-1/2" x 80-5/8"	Price
WD160	AS3 Walk Door 4/0 x 6/8	\$000.00

Item #	6/0 x 6/8 Actual Unit Size 75" x 81"	Price
WD200	AS3 Walk Door 6/0 x 6/8	\$000.00

Item #	3/0 x 6/8 Actual Unit Size 38-5/8" x 80-5/8"	Price
WD120	T-8 Therman Walk Door 3/0 x 6/8	\$000.00
WD130	T-8 Thermal Walk Door 3/0 x 6/8 RH 22" x 36" 1-Lite	\$000.00
WD140	T-8 Thermal Walk Door 3/0 x 6/8 LH 22" x 36" 1-Lite	\$000.00

Item #	4/0 x 6/8 Actual Unit Size 49-1/2" x 80-5/8"	Price
WD180	T-8 Thermal Walk Door 4/0 x 6/8	\$000.00

Item #	6/0 x 6/8 Actual Unit Size 75: x 81"	Price
WD240	T-8 Thermal Walk Door 6/0 x 6/8	\$000.00

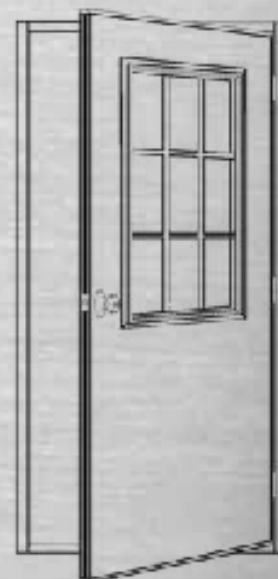

WINDOWS

Item #	Description	Price
WLP10	22" x 36" Window Lite Package	\$000.00
WLP20	9-Lite 22" x 36" Window Lite Package	\$000.00
SW100	36" x 20-1/2" Window w/Screen	\$00.00
SW110	46-1/2" x 20-1/2" Window w/Screen	\$00.00
SW120	48" x 36" Window - Insulated	\$000.00

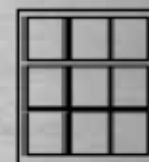

HAVE QUESTIONS? GIVE US A CALL TODAY AT 1-877-822-3530.

RIDGE VENT

Item #	Description	Color	Price
WRV11	10' Ridgevent 1.04 Sq Ft	Vent White	\$000.00
WRV12	10' Ridgevent 1.04 Sq Ft	Vent Green	\$000.00
WRV13	10' Ridgevent 1.04 Sq Ft	Vent Lighthouse	\$000.00
WRV14	10' Ridgevent 1.04 Sq Ft	Vent Taupe	\$000.00
WRV15	10' Ridgevent 1.04 Sq Ft	Vent Ash Gray	\$000.00
WRV16	10' Ridgevent 1.04 Sq Ft	Vent Ocean Blue	\$000.00
WRV17	10' Ridgevent 1.04 Sq Ft	Vent Tan	Call
WRV18	10' Ridgevent 1.04 Sq Ft	Vent Charcoal Gray	\$000.00
WRV19	10' Ridgevent 1.04 Sq Ft	Vent Red	\$000.00
WRV20	10' Ridgevent 1.04 Sq Ft	Vent Brown	\$000.00
WRV21	10' Ridgevent 1.04 Sq Ft	Vent Black	Call
WRV22	10' Ridgevent 1.04 Sq Ft	Vent Burgundy	\$000.00
WRV23	10' Ridgevent 1.04 Sq Ft	Vent Bone White	Call
WRV24	10' Ridgevent 1.04 Sq Ft	Vent Antique Bronze	Call
WRV27	10' Ridgevent 1.04 Sq Ft	Vent Dark Blue	Call
WRV28	10' Ridgevent 1.04 Sq Ft	Vent Pewter	Call
WRV29	10' Ridgevent 1.04 Sq Ft	Vent Forest Green	Call
WRV30	10' Ridgevent 1.04 Sq Ft	Vent Copper Penny	Call

TOUCH UP PAINT

Item #	Description	Price
Spray100	Touch Up Paint White	\$0.00
Spray101	Touch Up Paint Green	\$0.00
Spray102	Touch Up Paint Lightstone	\$0.00
Spray103	Touch Up Paint Taupe	\$0.00
Spray104	Touch Up Paint Ash Gray	\$0.00
Spray105	Touch Up Paint Ocean Blue	\$0.00
Spray106	Touch Up Paint Tan	\$0.00
Spray107	Touch Up Paint Charcoal Gray	\$0.00
Spray108	Touch Up Paint Red	\$0.00
Spray109	Touch Up Paint Brown	\$0.00
Spray110	Touch Up Paint Black	\$0.00
Spray111	Touch Up Paint Burgundy	\$0.00
Spray112	Touch Up Paint Bone White	\$0.00
Spray113	Touch Up Paint Antique Bronze	\$0.00
Spray114	Touch Up Paint Dark Blue	\$0.00
Spray118	Touch Up Paint Pewter	\$0.00
Spray119	Touch Up Paint Forest Green	\$0.00
Spray120	Touch Up Paint Copper Penny	\$0.00

WEATHERVANE & CUPOLA

Item #	Description	Color	Price
WC24	24" Cupola	Any Color	\$000.00
WV36	36" Cupola	Any Color	\$000.00

INSULATION & ALUMINUM TAPE

Item #	Description	Price
PI24	4' P2000 Insulation	\$000.00
PI26	6' P2000 Insulation	\$000.00
PI28	8' P2000 Insulation	\$000.00
AT10	2" x 150' Aluminum Tape	\$000.00
AT20	2" x 108' White Tape	\$000.00

BUTYL TAPE - SILICONE - SNOW GUARD

Item #	Description	Price
SCT40	3/32" x 1/2" - 50' Butyl Tape	\$0.00
WSIL	Silicone White or Clear	\$0.00
WSG40	Snow Guard	\$0.00

HAVE QUESTIONS? GIVE US A CALL TODAY AT 1-877-822-3530.



RAILS

SIDE RAIL - WHITE

Item #	Description	Price
WSR10	10' Side Rail - White	\$00.00
WSR12	12' Side Rail - White	\$00.00
WSR14	14' Side Rail - White	\$00.00
WSR16	16' Side Rail - White	\$00.00
WSR 18	18' Side Rail - White	\$00.00
WSR 20	120' Side Rail - White	Call

BOTTOM RAIL - WHITE

Item #	Description	Price
WBR10	10' Bottom Rail - White	\$00.00
WBR12	12' Bottom Rail - White	\$00.00
WBR14	14' Bottom Rail - White	\$00.00
WBR16	16' Bottom Rail - White	\$00.00
WBR18	18' Bottom Rail - White	\$00.00

"H" RAIL - WHITE

Item #	Description	Price
WH10	10' "H" Rail - White	\$00.00
WH12	12' "H" Rail - White	\$00.00
WH14	14' "H" Rail - White	\$00.00
WH16	16' "H" Rail - White	\$00.00
WH20	20' "H" Rail - White	\$00.00

SQUARE TRK - NO COVER

Item #	Description	Price
WSQ10	10' Square Trk - No Cover	\$00.00
WSQ12	12' Square Trk - No Cover	\$00.00
WSQ14	14' Square Trk - No Cover	\$00.00
WSQ16	16' Square Trk - No Cover	\$00.00
WSQ20	20' Square Trk - No Cover	\$00.00

SQUARE TRK - WHITE COVER

Item #	Description	Price
WSTW10	10' Square Trk - White Cover	\$00.00
WSTW12	12' Square Trk - White Cover	\$00.00
WSTW14	14' Square Trk - White Cover	\$00.00
WSTW16	16' Square Trk - White Cover	\$00.00

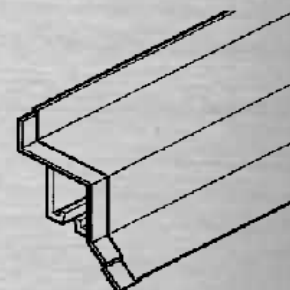
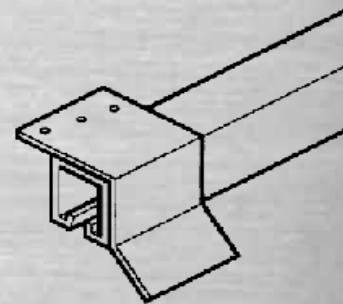
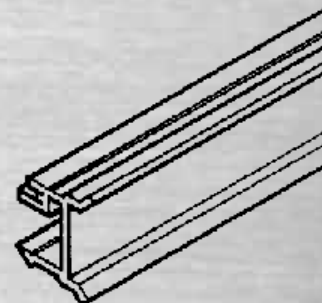
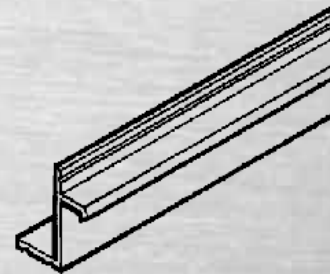
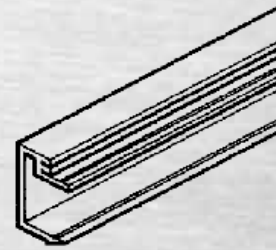

HAVE QUESTIONS? GIVE US A CALL TODAY AT 1-877-822-3530.

ROOF EDGE

WRO10	\$0.00	Galvanized
WRO11	\$0.00	White
WRO12	\$0.00	Brown
WRO13	\$0.00	Sandstone
WRO14	\$0.00	Terratone

**25 PER
CARTON**

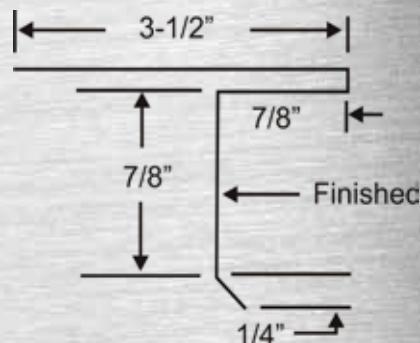

GUTTER APRON

WGP10	\$0.00	Galvanized
WGP11	\$0.00	White
WGP12	\$0.00	Brown
WGP13	\$0.00	Sandstone
WGP14	\$0.00	Terratone

**25 PER
CARTON**

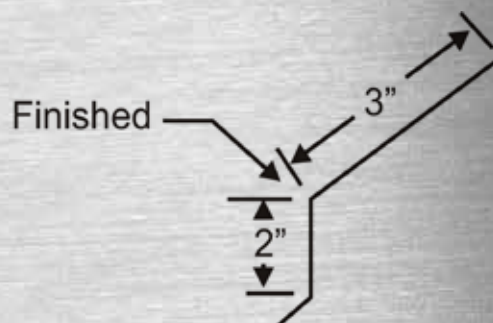

ROLL & VALLEY FLASHING

WGV4	\$00.00	4" Galvanized Valley	50' Roll
WGV6	\$00.00	6" Galvanized Valley	50' Roll
WGV8	\$00.00	8" Galvanized Valley	50' Roll
WGV10	\$00.00	10" Galvanized Valley	50' Roll
WGV12	\$00.00	12" Galvanized Valley	50' Roll
WGV14	\$00.00	14" Galvanized Valley	50' Roll
WGV16	\$00.00	16" Galvanized Valley	50' Roll
WGV20	\$00.00	20" Galvanized Valley	50' Roll
WGV24	\$00.00	24" Galvanized Valley	50' Roll
WGV28	\$00.00	28" Galvanized Valley	50' Roll
WGV30	\$00.00	30" Galvanized Valley	50' Roll
WGV36	\$00.00	36" Galvanized Valley	50' Roll

24" X 50' FLAT ROLL STOCK

WFS11	\$000.00	Galvanized
WFS12	\$000.00	Green
WFS13	\$000.00	Lightstone
WFS14	\$000.00	Taupe
WFS15	\$000.00	Ash Gray
WFS16	\$000.00	Ocean Blue
WFS17	\$000.00	Tan
WFS18	\$000.00	Charcoal Gray
WFS19	\$000.00	Red
WFS20	\$000.00	Brown
WFS21	\$000.00	Black
WFS22	\$000.00	Burgundy
WFS23	\$000.00	Bone White
WFS24	\$000.00	Antique Bronze
WFS25	\$000.00	Brite Red
WFS27	\$000.00	Dark Blue
WFS28	\$000.00	Pewter
WFS29	\$000.00	Forest Green
WFS30	\$000.00	Copper Penny

HAVE QUESTIONS? GIVE US A CALL TODAY AT 1-877-822-3530.



FAX US YOUR ORDERS AT (701) 749-5304 OR (701) 212-4392

26 GAUGE TRU-R-PANEL



Name	Item #	Description	per lin 1"	per sq. ft	per lin ft
Tru-R-Panel	WRP10	Galvanized	\$ -	\$ -	\$ -
Tru-R-Panel	WRP11	White	\$ -	\$ -	\$ -
Tru-R-Panel	WRP12	Green	\$ -	\$ -	\$ -
Tru-R-Panel	WRP13	Lightstone	\$ -	\$ -	\$ -
Tru-R-Panel	WRP14	Taupe	\$ -	\$ -	\$ -
Tru-R-Panel	WRP15	Ash Gray	\$ -	\$ -	\$ -
Tru-R-Panel	WRP16	Ocean Bllue	\$ -	\$ -	\$ -
Tru-R-Panel	WRP17	Tan	\$ -	\$ -	\$ -
Tru-R-Panel	WRP18	Charcoal Gray	\$ -	\$ -	\$ -
Tru-R-Panel	WRP19	Red	\$ -	\$ -	\$ -
Tru-R-Panel	WRP20	Brown	\$ -	\$ -	\$ -
Tru-R-Panel	WRP22	Burgundy	\$ -	\$ -	\$ -
Tru-R-Panel	WRP23	Bone White	\$ -	\$ -	\$ -
Tru-R-Panel	WRP24	Antique Bronze	\$ -	\$ -	\$ -
Tru-R-Panel	WRP60	Galvalume	\$ -	\$ -	\$ -
Tru-R-Panel	WRP38	Liner Panel White 20GA	\$ -	\$ -	\$ -
Tru-R-Panel	WRP68	Liner Panel White 26GA	\$ -	\$ -	\$ -

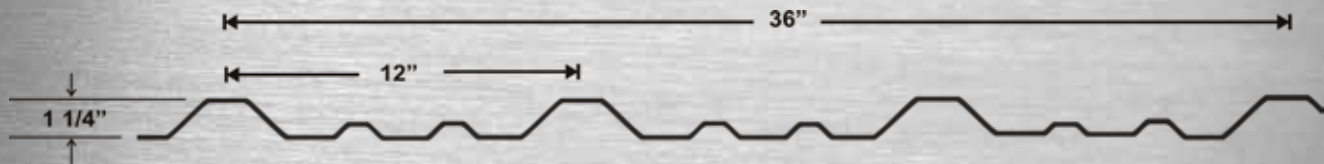

R-Panel	WRP98	12' R-Panel White Skylite	\$00.00
R-Panel	WRP90	R-Panel Large Outside Closures	\$00.00
R-Panel	WRP91	R-Panel Small Inside Closures	\$00.00

PROFILE VENT & UNISEAL

WRP85	Low Profile Vent	\$00.00
WUS12	Uniseal 20' Roll 1-1/2" x 1-1/2"	\$00.00



HAVE QUESTIONS? GIVE US A CALL TODAY AT 1-877-822-3530.



HEAD TRIM

WHT10	\$00.00	Galvanized
WHT11	\$00.00	White
WHT12		Green
WHT13		Lightstone
WHT14		Taupe
WHT15		Ash Gray
WHT16		Ocean Blue
WHT17		Tan
WHT18		Charcoal Gray
WHT19		Red
WHT20		Brown
WHT21		Black
WHT22		Burgundy
WHT23		Bone White
WHT24		Antique Bronze
WHT25		Brite Red
WHT27		Dark Blue

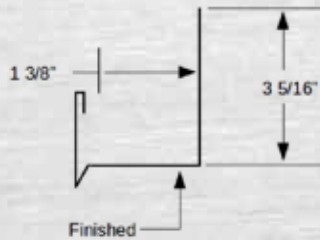

1-3/8" J TRIM

WJM10	\$00.00	Galvanized
WJM11	\$00.00	White
WJM12		Green
WJM13		Lightstone
WJM14		Taupe
WJM15		Ash Gray
WJM16		Ocean Blue
WJM17		Tan
WJM18		Charcoal Gray
WJM19		Red
WJM20		Brown
WJM21		Black
WJM22		Burgundy
WJM23		Bone White
WJM24		Antique Bronze
WJM25		Brite Red
WJM27		Dark Blue

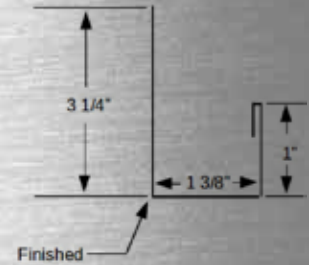

EAVE FLASHING

WEF10	\$00.00	Galvanized
WEF11	\$00.00	White
WEF12		Green
WEF13		Lightstone
WEF14		Taupe
WEF15		Ash Gray
WEF16		Ocean Blue
WEF17		Tan
WEF18		Charcoal Gray
WEF19		Red
WEF20		Brown
WEF21		Black
WEF22		Burgundy
WEF23		Bone White
WEF24		Antique Bronze
WEF25		Brite Red
WEF27		Dark Blue

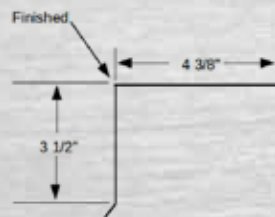

BASE CLOSURE ASSEMBLY

WBA10	\$00.00	Galvanized
WBA11	\$00.00	White
WBA12		Green
WBA13		Lightstone
WBA14		Taupe
WBA15		Ash Gray
WBA16		Ocean Blue
WBA17		Tan
WBA18		Charcoal Gray
WBA19		Red
WBA20		Brown
WBA21		Black
WBA22		Burgundy
WBA23		Bone White
WBA24		Antique Bronze
WBA25		Brite Red
WBA27		Dark Blue

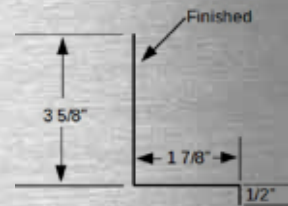

ZEE TRIM

WZE10	\$00.00	Galvanized
WZE11	\$00.00	White
WZE12		Green
WZE13		Lightstone
WZE14		Taupe
WZE15		Ash Gray
WZE16		Ocean Blue
WZE17		Tan
WZE18		Charcoal Gray
WZE19		Red
WZE20		Brown
WZE21		Black
WZE22		Burgundy
WZE23		Bone White
WZE24		Antique Bronze
WZE25		Brite Red
WZE27		Dark Blue

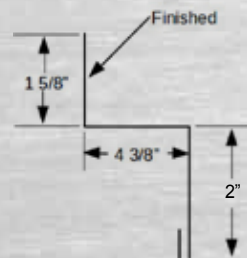

RAT GUARD

WRG10	\$00.00	Galvanized
WRG11	\$00.00	White
WRG12		Green
WRG13		Lightstone
WRG14		Taupe
WRG15		Ash Gray
WRG16		Ocean Blue
WRG17		Tan
WRG18		Charcoal Gray
WRG19		Red
WRG20		Brown
WRG21		Black
WRG22		Burgundy
WRG23		Bone White
WRG24		Antique Bronze
WRG25		Brite Red
WRG27		Dark Blue

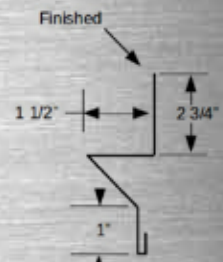

OUTSIDE TRIM

WOA10	\$00.00	Galvanized
WOA11	\$00.00	White
WOA12		Green
WOA13		Lightstone
WOA14		Taupe
WOA15		Ash Gray
WOA16		Ocean Blue
WOA17		Tan
WOA18		Charcoal Gray
WOA19		Red
WOA20		Brown
WOA21		Black
WOA22		Burgundy
WOA23		Bone White
WOA24		Antique Bronze
WOA25		Brite Red
WOA27		Dark Blue

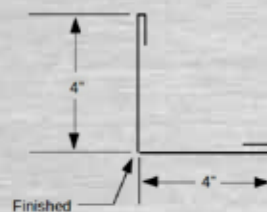

1-3/8" X 7/8" DOUBLE J

DJ10	\$00.00	Galvanized
DJ11	\$00.00	White
DJ12		Green
DJ13		Lightstone
DJ14		Taupe
DJ15		Ash Gray
DJ16		Ocean Blue
DJ17		Tan
DJ18		Charcoal Gray
DJ19		Red
DJ20		Brown
DJ21		Black
DJ22		Burgundy
DJ23		Bone White
DJ24		Antique Bronze
DJ25		Brite Red
DJ27		Dark Blue

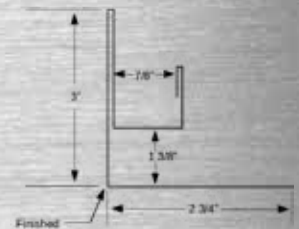

HAVE QUESTIONS? GIVE US A CALL TODAY AT 1-877-822-3530.



10'6"		12'6"		14'3"		16'3"		CORNER TRIM
WCA10	\$00.00	WCA40	\$00.00	WCA60	\$00.00	WCA80	\$00.00	Galvanized
WCA11	\$00.00	WCA41	\$00.00	WCA61	\$00.00	WCA81	\$00.00	White
WCA12		WCA42		WCA62		WCA82		Green
WCA13		WCA43		WCA63		WCA83		Lightstone
WCA14		WCA44		WCA64		WCA84		Taupe
WCA15		WCA45		WCA65		WCA85		Ash Gray
WCA16		WCA46		WCA66		WCA86		Ocean Blue
WCA17		WCA47		WCA67		WCA87		Tan
WCA18		WCA48		WCA68		WCA88		Charcoal Gray
WCA19		WCA49		WCA69		WCA89		Red
WCA20		WCA50		WCA70		WCA90		Brown
WCA21		WCA51		WCA71		WCA91		Black
WCA22		WCA52		WCA72		WCA92		Burgundy
WCA23		WCA53		WCA73		WCA93		Bone White
WCA24		WCA54		WCA74		WCA94		Antique Bronze
WCA25		WCA55		WCA75		WCA95		Camouflage
WCA27		WCA57		WCA77		WCA97		Dark Blue

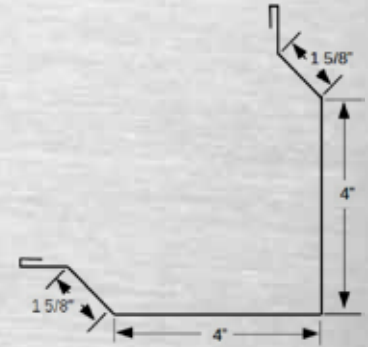

10'6"		12'6"		14'3"		16'3"		INSIDE CORNER
WIN10	\$00.00	WIN40	\$00.00	WIN60	\$00.00	WIN80	\$00.00	Galvanized
WIN11	\$00.00	WIN41	\$00.00	WIN61	\$00.00	WIN81	\$00.00	White
WIN12		WIN42		WIN62		WIN82		Green
WIN13		WIN43		WIN63		WIN83		Lightstone
WIN14		WIN44		WIN64		WIN84		Taupe
WIN15		WIN45		WIN65		WIN85		Ash Gray
WIN16		WIN46		WIN66		WIN86		Ocean Blue
WIN17		WIN47		WIN67		WIN87		Tan
WIN18		WIN48		WIN68		WIN88		Charcoal Gray
WIN19		WIN49		WIN69		WIN89		Red
WIN20		WIN50		WIN70		WIN90		Brown
WIN21		WIN51		WIN71		WIN91		Black
WIN22		WIN52		WIN72		WIN92		Burgundy
WIN23		WIN53		WIN73		WIN93		Bone White
WIN24		WIN54		WIN74		WIN94		Antique Bronze
WIN25		WIN55		WIN75		WIN95		Camouflage
WIN27		WIN57		WIN77		WIN97		Dark Blue

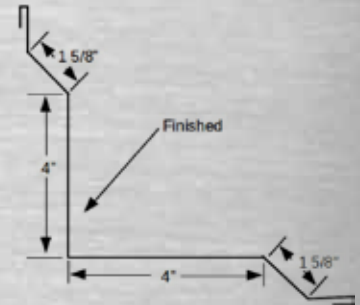

10'6"		12'6"		14'3"		16'3"		R-PANEL DOOR TRIM
WRJ10	\$00.00	WRJ40	\$00.00	WRJ60	\$00.00	WRJ80	\$00.00	Galvanized
WRJ11	\$00.00	WRJ41	\$00.00	WRJ61	\$00.00	WRJ81	\$00.00	White
WRJ12		WRJ42		WRJ62		WRJ82		Green
WRJ13		WRJ43		WRJ63		WRJ83		Lightstone
WRJ14		WRJ44		WRJ64		WRJ84		Taupe
WRJ15		WRJ45		WRJ65		WRJ85		Ash Gray
WRJ16		WRJ46		WRJ66		WRJ86		Ocean Blue
WRJ17		WRJ47		WRJ67		WRJ87		Tan
WRJ18		WRJ48		WRJ68		WRJ88		Charcoal Gray
WRJ19		WRJ49		WRJ69		WRJ89		Red
WRJ20		WRJ50		WRJ70		WRJ90		Brown
WRJ21		WRJ51		WRJ71		WRJ91		Black
WRJ22		WRJ52		WRJ72		WRJ92		Burgundy
WRJ23		WRJ53		WRJ73		WRJ93		Bone White
WRJ24		WRJ54		WRJ74		WRJ94		Antique Bronze
WRJ25		WRJ55		WRJ75		WRJ95		Camouflage
WRJ27		WRJ57		WRJ77		WRJ97		Dark Blue

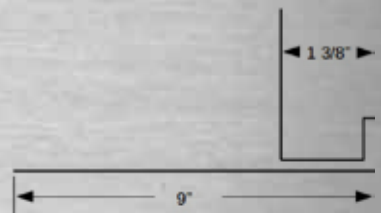

HAVE QUESTIONS? GIVE US A CALL TODAY AT 1-877-822-3530.

UNIVERSAL RIDGE

WUR10	\$00.00	Galvanized
WUR11	\$00.00	White
WUR12		Green
WUR13		Lightstone
WUR14		Taupe
WUR15		Ash Gray
WUR16		Ocean Blue
WUR17		Tan
WUR18		Charcoal Gray
WUR19		Red
WUR20		Brown
WUR21		Black
WUR22		Burgundy
WUR23		Bone White
WUR24		Antique Bronze
WUR25		Brite Red
WUR27		Dark Blue

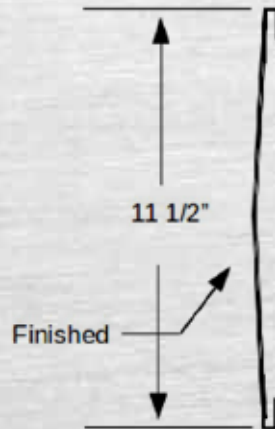

OPEN C CHANNEL

WOC10	\$00.00	Galvanized
WOC11	\$00.00	White
WOC12		Green
WOC13		Lightstone
WOC14		Taupe
WOC15		Ash Gray
WOC16		Ocean Blue
WOC17		Tan
WOC18		Charcoal Gray
WOC19		Red
WOC20		Brown
WOC21		Black
WOC22		Burgundy
WOC23		Bone White
WOC24		Antique Bronze
WOC25		Brite Red
WOC27		Dark Blue



DOWN/SPOUT ASSEMBLY

WDS10	\$00.00	Galvanized
WDS11	\$00.00	White
WDS12		Green
WDS13		Lightstone
WDS14		Taupe
WDS15		Ash Gray
WDS16		Ocean Blue
WDS17		Tan
WDS18		Charcoal Gray
WDS19		Red
WDS20		Brown
WDS21		Black
WDS22		Burgundy
WDS23		Bone White
WDS24		Antique Bronze
WDS25		Brite Red
WDS27		Dark Blue

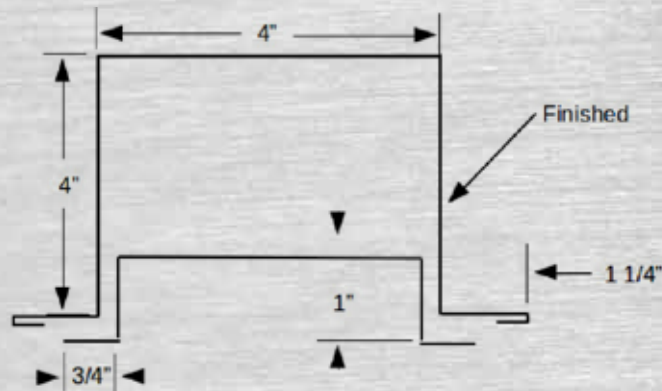

HAVE QUESTIONS? GIVE US A CALL TODAY AT 1-877-822-3530.



SOFFIT PANELS

SOFFIT PANELS FOR TRU-D -RIB & TRU-A-PANEL

WSP11	12" x 36"	Soffit Panel	White	\$0.00	WNO11	12" x 36"	Solid Panel	White	\$0.00
WSP12	12" x 36"	Soffit Panel	Green		WNO12	12" x 36"	Solid Panel	Green	
WSP13	12" x 36"	Soffit Panel	Lightstone		WNO13	12" x 36"	Solid Panel	Lightstone	
WSP14	12" x 36"	Soffit Panel	Taupe		WNO14	12" x 36"	Solid Panel	Taupe	
WSP15	12" x 36"	Soffit Panel	Ash Gray		WNO15	12" x 36"	Solid Panel	Ash Gray	
WSP16	12" x 36"	Soffit Panel	Ocean Blue		WNO16	12" x 36"	Solid Panel	Ocean Blue	
WSP17	12" x 36"	Soffit Panel	Tan		WNO17	12" x 36"	Solid Panel	Tan	
WSP18	12" x 36"	Soffit Panel	Charcoal Gray		WNO18	12" x 36"	Solid Panel	Charcoal Gray	
WSP19	12" x 36"	Soffit Panel	Red		WNO19	12" x 36"	Solid Panel	Red	
WSP20	12" x 36"	Soffit Panel	Brown		WNO20	12" x 36"	Solid Panel	Brown	
WSP21	12" x 36"	Soffit Panel	Black		WNO21	12" x 36"	Solid Panel	Black	
WSP22	12" x 36"	Soffit Panel	Burgundy		WNO22	12" x 36"	Solid Panel	Burgundy	
WSP23	12" x 36"	Soffit Panel	Bone White		WNO23	12" x 36"	Solid Panel	Bone White	
WSP24	12" x 36"	Soffit Panel	Antique Bronze		WNO24	12" x 36"	Solid Panel	Antique Bronze	
WSP27	12" x 36"	Soffit Panel	Dark Blue		WNO27	12" x 36"	Solid Panel	Dark Blue	
WSP28	12" x 36"	Soffit Panel	Pewter		WNO28	12" x 36"	Solid Panel	Pewter	
WSP29	12" x 36"	Soffit Panel	Forest Green		WNO29	12" x 36"	Solid Panel	Forest Green	

SOFFIT PANELS FOR TRU-D -RIB & TRU-A-PANEL

WSP41	24" x 36"	Soffit Panel	White	\$0.00	WNO41	24" x 36"	Solid Panel	White	\$0.00
WSP42	24" x 36"	Soffit Panel	Green		WNO42	24" x 36"	Solid Panel	Green	
WSP43	24" x 36"	Soffit Panel	Lightstone		WNO43	24" x 36"	Solid Panel	Lightstone	
WSP44	24" x 36"	Soffit Panel	Taupe		WNO44	24" x 36"	Solid Panel	Taupe	
WSP45	24" x 36"	Soffit Panel	Ash Gray		WNO45	24" x 36"	Solid Panel	Ash Gray	
WSP46	24" x 36"	Soffit Panel	Ocean Blue		WNO46	24" x 36"	Solid Panel	Ocean Blue	
WSP47	24" x 36"	Soffit Panel	Tan		WNO47	24" x 36"	Solid Panel	Tan	
WSP48	24" x 36"	Soffit Panel	Charcoal Gray		WNO48	24" x 36"	Solid Panel	Charcoal Gray	
WSP49	24" x 36"	Soffit Panel	Red		WNO49	24" x 36"	Solid Panel	Red	
WSP50	24" x 36"	Soffit Panel	Brown		WNO50	24" x 36"	Solid Panel	Brown	
WSP51	24" x 36"	Soffit Panel	Black		WNO51	24" x 36"	Solid Panel	Black	
WSP52	24" x 36"	Soffit Panel	Burgundy		WNO52	24" x 36"	Solid Panel	Burgundy	
WSP53	24" x 36"	Soffit Panel	Bone White		WNO53	24" x 36"	Solid Panel	Bone White	
WSP54	24" x 36"	Soffit Panel	Antique Bronze		WNO54	24" x 36"	Solid Panel	Antique Bronze	
WSP57	24" x 36"	Soffit Panel	Dark Blue		WNO57	24" x 36"	Solid Panel	Dark Blue	
WSP58	24" x 36"	Soffit Panel	Pewter		WNO58	24" x 36"	Solid Panel	Pewter	
WSP59	24" x 36"	Soffit Panel	Forest Green		WNO59	24" x 36"	Solid Panel	Forest Green	

SOFFIT PANELS FOR TRU-D -RIB & TRU-A-PANEL

WSP61	36" x 36"	Soffit Panel	White	\$0.00	WNO61	36" x 36"	Solid Panel	White	\$0.00
WSP62	36" x 36"	Soffit Panel	Green		WNO62	36" x 36"	Solid Panel	Green	
WSP63	36" x 36"	Soffit Panel	Lightstone		WNO63	36" x 36"	Solid Panel	Lightstone	
WSP64	36" x 36"	Soffit Panel	Taupe		WNO64	36" x 36"	Solid Panel	Taupe	
WSP65	36" x 36"	Soffit Panel	Ash Gray		WNO65	36" x 36"	Solid Panel	Ash Gray	
WSP66	36" x 36"	Soffit Panel	Ocean Blue		WNO66	36" x 36"	Solid Panel	Ocean Blue	
WSP67	36" x 36"	Soffit Panel	Tan		WNO67	36" x 36"	Solid Panel	Tan	
WSP68	36" x 36"	Soffit Panel	Charcoal Gray		WNO68	36" x 36"	Solid Panel	Charcoal Gray	
WSP69	36" x 36"	Soffit Panel	Red		WNO69	36" x 36"	Solid Panel	Red	
WSP70	36" x 36"	Soffit Panel	Brown		WNO70	36" x 36"	Solid Panel	Brown	
WSP71	36" x 36"	Soffit Panel	Black		WNO71	36" x 36"	Solid Panel	Black	
WSP72	36" x 36"	Soffit Panel	Burgundy		WNO72	36" x 36"	Solid Panel	Burgundy	
WSP73	36" x 36"	Soffit Panel	Bone White		WNO73	36" x 36"	Solid Panel	Bone White	
WSP74	36" x 36"	Soffit Panel	Antique Bronze		WNO74	36" x 36"	Solid Panel	Antique Bronze	
WSP77	36" x 36"	Soffit Panel	Dark Blue		WNO77	36" x 36"	Solid Panel	Dark Blue	
WSP78	36" x 36"	Soffit Panel	Pewter		WNO78	36" x 36"	Solid Panel	Pewter	
WSP79	36" x 36"	Soffit Panel	Forest Green		WNO79	36" x 36"	Solid Panel	Forest Green	

SOFFIT PANELS FOR TRU-D -RIB & TRU-A-PANEL

WSP81	48" x 36"	Soffit Panel	White	\$0.00	WNO81	48" x 36"	Solid Panel	White	\$0.00
WSP82	48" x 36"	Soffit Panel	Green		WNO82	48" x 36"	Solid Panel	Green	
WSP83	48" x 36"	Soffit Panel	Lightstone		WNO83	48" x 36"	Solid Panel	Lightstone	
WSP84	48" x 36"	Soffit Panel	Taupe		WNO84	48" x 36"	Solid Panel	Taupe	
WSP85	48" x 36"	Soffit Panel	Ash Gray		WNO85	48" x 36"	Solid Panel	Ash Gray	
WSP86	48" x 36"	Soffit Panel	Ocean Blue		WNO86	48" x 36"	Solid Panel	Ocean Blue	
WSP87	48" x 36"	Soffit Panel	Tan		WNO87	48" x 36"	Solid Panel	Tan	
WSP88	48" x 36"	Soffit Panel	Charcoal Gray		WNO88	48" x 36"	Solid Panel	Charcoal Gray	
WSP89	48" x 36"	Soffit Panel	Red		WNO89	48" x 36"	Solid Panel	Red	
WSP90	48" x 36"	Soffit Panel	Brown		WNO90	48" x 36"	Solid Panel	Brown	
WSP91	48" x 36"	Soffit Panel	Black		WNO91	48" x 36"	Solid Panel	Black	
WSP92	48" x 36"	Soffit Panel	Burgundy		WNO92	48" x 36"	Solid Panel	Burgundy	
WSP93	48" x 36"	Soffit Panel	Bone White		WNO93	48" x 36"	Solid Panel	Bone White	
WSP94	48" x 36"	Soffit Panel	Antique Bronze		WNO94	48" x 36"	Solid Panel	Antique Bronze	
WSP97	48" x 36"	Soffit Panel	Dark Blue		WNO97	48" x 36"	Solid Panel	Dark Blue	
WSP98	48" x 36"	Soffit Panel	Pewter		WNO98	48" x 36"	Solid Panel	Pewter	
WSP99	48" x 36"	Soffit Panel	Forest Green		WNO99	48" x 36"	Solid Panel	Forest Green	

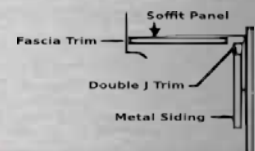

WE CAN GUT SOFFIT TO YOUR JOB SPECIFICATIONS!



CENTER VENT SOFFIT (CARTON ONLY, 15 PER CARTON)

WVF41	24" x 16" Vented Soffit	White	\$00.00
WVF42	24" x 16" Vented Soffit	Green	\$00.00
WVF43	24" x 16" Vented Soffit	Lightstone	\$00.00
WVF44	24" x 16" Vented Soffit	Taupe	\$00.00
WVF45	24" x 16" Vented Soffit	Ash Gray	\$00.00
WVF46	24" x 16" Vented Soffit	Ocean Blue	\$00.00
WVF47	24" x 16" Vented Soffit	Tan	\$00.00
WVF48	24" x 16" Vented Soffit	Charcoal Gray	\$00.00
WVF49	24" x 16" Vented Soffit	Red	\$00.00
WVF50	24" x 16" Vented Soffit	Brown	\$00.00
WVF51	24" x 16" Vented Soffit	Black	\$00.00
WVF52	24" x 16" Vented Soffit	Burgundy	\$00.00
WVF53	24" x 16" Vented Soffit	Bone White	\$00.00
WVF54	24" x 16" Vented Soffit	Antique Bronze	\$00.00
WVF55	24" x 16" Vented Soffit	Brite Red	\$00.00
WVF57	24" x 16" Vented Soffit	Dark Blue	\$00.00
WVF58	24" x 16" Vented Soffit	Pewter Gray	\$00.00
WVF59	24" x 16" Vented Soffit	Forest Green	\$00.00
WVF60	24" x 16" Vented Soffit	Copper Penny	\$00.00

SOLID SOFFIT (CARTON ONLY, 15 PER CARTON)

WSS41	24" x 16" Solid Soffit	White	\$00.00
WSS42	24" x 16" Solid Soffit	Green	\$00.00
WSS43	24" x 16" Solid Soffit	Lightstone	\$00.00
WSS44	24" x 16" Solid Soffit	Taupe	\$00.00
WSS45	24" x 16" Solid Soffit	Ash Gray	\$00.00
WSS46	24" x 16" Solid Soffit	Ocean Blue	\$00.00
WSS47	24" x 16" Solid Soffit	Tan	\$00.00
WSS48	24" x 16" Solid Soffit	Charcoal Gray	\$00.00
WSS49	24" x 16" Solid Soffit	Red	\$00.00
WSS50	24" x 16" Solid Soffit	Brown	\$00.00
WSS51	24" x 16" Solid Soffit	Black	\$00.00
WSS52	24" x 16" Solid Soffit	Burgundy	\$00.00
WSS53	24" x 16" Solid Soffit	Bone White	\$00.00
WSS54	24" x 16" Solid Soffit	Antique Bronze	\$00.00
WSS55	24" x 16" Solid Soffit	Brite Red	\$00.00
WSS57	24" x 16" Solid Soffit	Dark Blue	\$00.00
WSS58	24" x 16" Solid Soffit	Pewter Gray	\$00.00
WSS59	24" x 16" Solid Soffit	Forest Green	\$00.00
WSS60	24" x 16" Solid Soffit	Copper Penny	\$00.00

CENTER VENT SOFFIT (CARTON ONLY, 12 PER CARTON)

WVF61	144" x 16" Vented Soffit	White	\$00.00
WVF62	144" x 16" Vented Soffit	Green	\$00.00
WVF63	144" x 16" Vented Soffit	Lightstone	\$00.00
WVF64	144" x 16" Vented Soffit	Taupe	\$00.00
WVF65	144" x 16" Vented Soffit	Ash Gray	\$00.00
WVF66	144" x 16" Vented Soffit	Ocean Blue	\$00.00
WVF67	144" x 16" Vented Soffit	Tan	\$00.00
WVF68	144" x 16" Vented Soffit	Charcoal Gray	\$00.00
WVF69	144" x 16" Vented Soffit	Red	\$00.00
WVF70	144" x 16" Vented Soffit	Brown	\$00.00
WVF71	144" x 16" Vented Soffit	Black	\$00.00
WVF72	144" x 16" Vented Soffit	Burgundy	\$00.00
WVF73	144" x 16" Vented Soffit	Bone White	\$00.00
WVF74	144" x 16" Vented Soffit	Antique Bronze	\$00.00
WVF75	144" x 16" Vented Soffit	Brite Red	\$00.00
WVF77	144" x 16" Vented Soffit	Dark Blue	\$00.00
WVF78	144" x 16" Vented Soffit	Pewter Gray	\$00.00
WVF79	144" x 16" Vented Soffit	Forest Green	\$00.00
WVF80	144" x 16" Vented Soffit	Copper Penny	\$00.00

SOLID SOFFIT (CARTON ONLY, 12 PER CARTON)

WSS61	144" x 16" Solid Soffit	White	\$00.00
WSS62	144" x 16" Solid Soffit	Green	\$00.00
WSS63	144" x 16" Solid Soffit	Lightstone	\$00.00
WSS64	144" x 16" Solid Soffit	Taupe	\$00.00
WSS65	144" x 16" Solid Soffit	Ash Gray	\$00.00
WSS66	144" x 16" Solid Soffit	Ocean Blue	\$00.00
WSS67	144" x 16" Solid Soffit	Tan	\$00.00
WSS68	144" x 16" Solid Soffit	Charcoal Gray	\$00.00
WSS69	144" x 16" Solid Soffit	Red	\$00.00
WSS70	144" x 16" Solid Soffit	Brown	\$00.00
WSS71	144" x 16" Solid Soffit	Black	\$00.00
WSS72	144" x 16" Solid Soffit	Burgundy	\$00.00
WSS73	144" x 16" Solid Soffit	Bone White	\$00.00
WSS74	144" x 16" Solid Soffit	Antique Bronze	\$00.00
WSS75	144" x 16" Solid Soffit	Brite Red	\$00.00
WSS77	144" x 16" Solid Soffit	Dark Blue	\$00.00
WSS78	144" x 16" Solid Soffit	Pewter Gray	\$00.00
WSS79	144" x 16" Solid Soffit	Forest Green	\$00.00
WSS80	144" x 16" Solid Soffit	Copper Penny	\$00.00

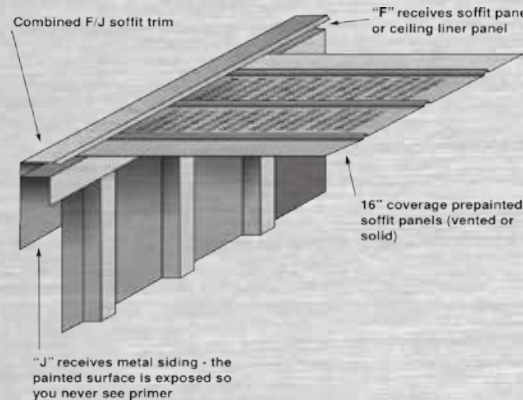
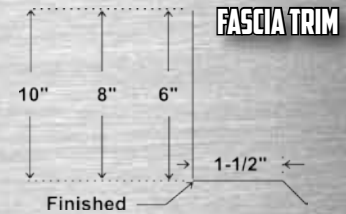
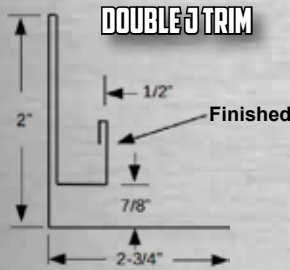

HAVE QUESTIONS? GIVE US A CALL TODAY AT 1-877-822-3530.





Specializing in Products for the Post Frame Industry

THE INDUSTRY'S LEADING SUPPLIER OF SLIDE FRAME COMPONENTS



**Two distinct 1 1/2" profiles • One 3 1/2" profile
For wood/metal and all metal framed slide doors**

• COLOR MATCHED •

Over 27 powder coat colors for exact match to most rollformers metal siding.

• JOB PACKED •

No minimum order to buy - job pack all of your color coordinated doors at one low price.
Or stock your most popular colors for even greater savings!

• AVAILABILITY •

Quick lead time, 5 - 10 business days in weekly route truck delivery zones.

HAVE QUESTIONS? GIVE US A CALL TODAY AT 1-877-822-3530.



SLIDING DOOR ASSEMBLY INSTRUCTIONS

NOTE: Fastener placement is up to the discretion of installer, a fastener groove is provided on backside of aluminum rail as an assembly guideline. Below is a process MWI has developed to help with installation.

1 Insert the header into the aluminum side rail and fasten at top with (1) #10 x 1" self driller.
(other screws are added after door is square)

When using 3300 series rail, (2) MWI steel box girts are suggested in the header position to ensure proper stability.
(see figure 4)

2 Attach side rail or H rail to the other end of the header assembly and fasten with (1) #10 x 1" self driller. One H rail is recommended for snug fit on on split door applications as shown to the right

3 Insert the bottom rail into the side rail and fasten with (1) #10 x 1" self driller. 2244 bottom rail is shown to the right
(other screws are added after door is square)

Contractor may utilize a treated 2x6 in lieu of steel box girt with the 2201 bottom rail if desired *(see figure 2)*

4 Position box girts 24" O.C. apart, starting from the bottom of the door, checking for squareness. Fasten each girt with (1) #10 x 1" self driller per side. Make final check on door squareness and fasten (1) additional screw per box girt per side.
(each horizontal box girt should have 2 screws per side)

Installer may then choose to turn door over, recheck for squareness and repeat fastening procedure for added stability

DOOR HEIGHT	BOX GIRT QTY
8'	4
10'	5
12'	6
14'	7

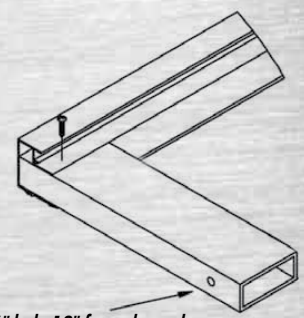

Drill 9/16" hole 12" from the end of the header for trolley hanger
(24" for panels wider than 10')

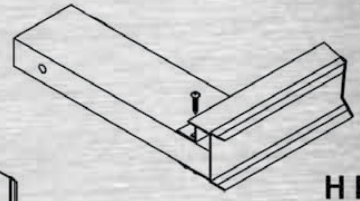

H RAIL

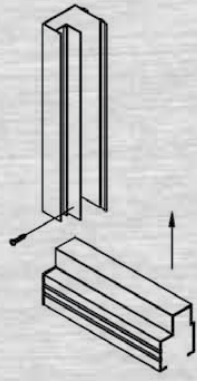

NOTE: Installer is responsible for verification that door weight is within hardware capacities *(see specifications in MWI track & hardware catalog)*

HAVE QUESTIONS? GIVE US A CALL TODAY AT 1-877-822-3530.



FAX US YOUR ORDERS AT (701) 749-5304 OR (701) 212-4392

**- 1 1/2" System -
1600 Series**

**- 1 1/2" System -
2200 Series**

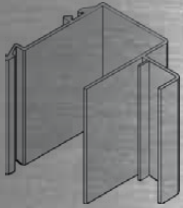

1600AV siderail

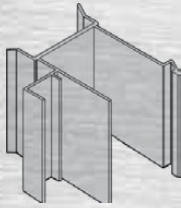

1600HV H-rail
- double couple for split doors -

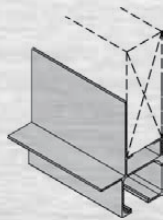

1600WB bottom rail

Available lengths: 8', 10', 12', 14' & 16'

Figure 1

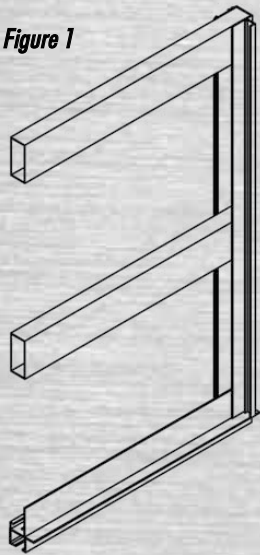

1600 series rail
w/ 1600WB bottom rail
shown with steel box girt

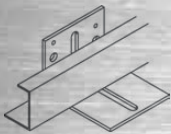

TRG bottom guide system
- available in 5' & 10' sections -
used with 1600WB bottom rail

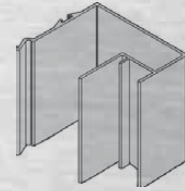

2200 siderail

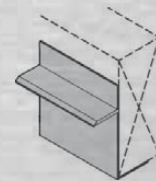

2201 bottom rail

Available lengths: 8', 10', 12', 14', 16', 18' & 20'

Figure 2

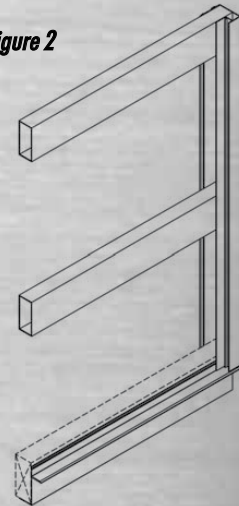

2200 series rail
w/ 2201 bottom rail
shown with steel box girt

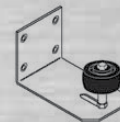

BC92S stay roller
used with 2201 bottom rail

HAVE QUESTIONS? GIVE US A CALL TODAY AT 1-877-822-3530.



**- 1 1/2" System -
2200 Series**

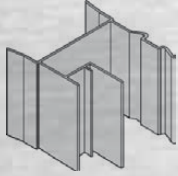

2216 H-rail
- double couple for split doors -

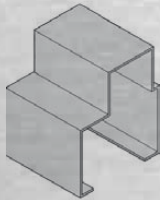

2244 bottom rail

Available lengths: 8', 10', 12', 14', 16', 18' & 20'

Figure 3

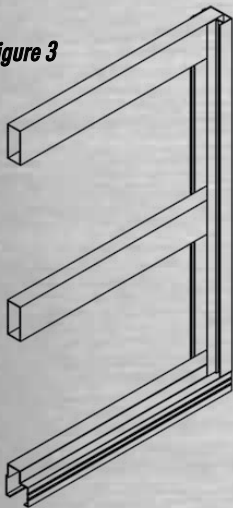

2200 series rail
w/ 2244 bottom rail
shown with steel box girt

TBSG bottom guide system
- available in 6', 8' & 10' sections -
used with 2244 bottom rail

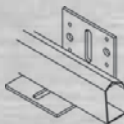

**- 3 1/2" System -
3300 Series**

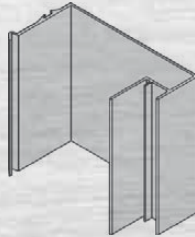

3391 siderail

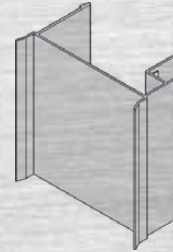

3396 H-rail
- double couple for split doors -

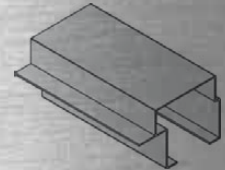

3394 bottom rail

Available lengths: 8', 10', 12', 14', 16', 18' & 20'

Figure 4

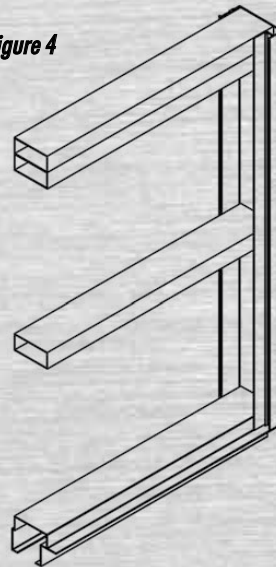

3300 series rail
w/ 3394 bottom rail
shown with steel box girt

TBSG bottom guide system
- available in 6', 8' & 10' sections -
used with 3394 bottom rail

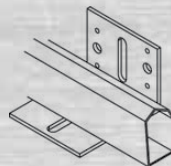

HAVE QUESTIONS? GIVE US A CALL TODAY AT 1-877-822-3530.



FAX US YOUR ORDERS AT (701) 749-5304 OR (701) 212-4392

Specializing in Products for the Post Frame Industry



THE INDUSTRY'S LEADING MANUFACTURER OF LIGHT GAUGE STEEL CUPOLAS

We offer a large color palette to match most roll formers metal sheeting.



24"
w/windows and
Premium Flashing

36"
w/louvers and
Premium Flashing



**SQUARE CUPOLAS AVAILABLE IN
24", 36", 48" & 66"
OR
48" OCTAGON**

Prepainted 29ga construction. Available in over 100 standard colors plus Kynar. All metal edges are hemmed. No need to worry about red-rust. Bird screen included for mounting in curb. Roof and sides interlock for weather-tite connection. 24", 36" & 48" ship knocked-down; 66" & octagon ship assembled.

HAVE QUESTIONS? GIVE US A CALL TODAY AT 1-877-822-3530.



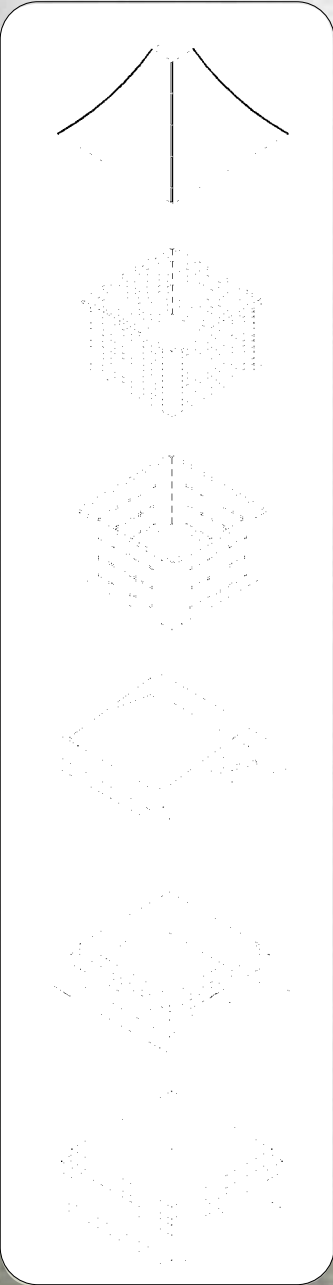

Model: C240/C360/C480/C660

24" x 24", 36" x 36", 48" x 48", 66" x 66" Cupola Roof
 Installs on top of the side sections
 Ships knocked-down

Model: C245/C365/C485/C665

24" x 24", 36" x 36", 48" x 48", 66" x 66" Cupola Sides
 Installs on top of any of the flashings,
 Ships knocked-down

Model: C245W/C365W/C485W/C665W

24" x 24", 36" x 36", 48" x 48", 66" x 66" Cupola Sides with Windows
 Installs on top of any of the flashings, Ships knocked-down

Grid Patterns: 24" = 2 x 2 (shown on reverse)
 36" & 48" = 3 x 2 (as shown on component diagram)
 66" = 2 x 3 (two sets per side)
 48" octagon = 2 x 4 (shown on reverse)

Model: C241/C361/C481

6-piece Standard Flashing Kit
 Specific roof pitch must be ordered and
 wood support curb is field fabricated
 Ships knocked-down

Model: C241P/C361P/C481P/C661P

10-piece Premium Flashing Kit
 Specific roof pitch must be ordered and wood support
 curb is field fabricated. (Frame is 3/2" higher than standard)
 Ships knocked-down

Model: C242/C362/C482 Universal Base

Factory assembled base that requires no wood curb.
 Adapts to roof pitches from 1/12 up to 7/12. The same
 unit is used for vented and non-vented applications.
 Mounts on the top of steel roofing or on perlin's.
 Both new construction and retrofits utilize the same base.

Available with either the universal flashing kit or powder coat* option.

**powder coat option available in 28 colors*

BASE SIZE	24" x 24"	36" x 36"	48" x 48"	66" x 66"	48" OCTAGON
TOTAL HEIGHT	37"	44"	59"	72"	77"
BUILDING WIDTH*	24' - 30'	36' - 40'	48' - 60'	USER DEFINED	USER DEFINED
BUILDING LENGTH*	24' CENTERS	36' CENTERS	48' CENTERS	USER DEFINED	USER DEFINED
WEATHERVANE*	24" OR 30"	30"	46"	46" OR LARGER	46" OR LARGER

*recommended; contact MWI for details

HAVE QUESTIONS? GIVE US A CALL TODAY AT 1-877-822-3530.



FAX US YOUR ORDERS AT (701) 749-5304 OR (701) 212-4392

Stock Weathervanes

24"

30"

46"



Country Doctor



Antique Auto



Pig



Buck



Eagle



Eagle



Country Doctor



Rooster



Cow



Horse



Horse



Duck



Tractor



Eagle



Rooster



Rooster



Horse



Sailboat



Pheasant



Sailboat

30" Non-Stock Weathervanes

Non-Stock weathervanes come in a standard black finish but are available in color (shown). Please contact MWI for details.



HAVE QUESTIONS? GIVE US A CALL TODAY AT 1-877-822-3530.





image above shows 66" cupola with louvered sides



Universal base adjustable on job
from 1/12 up to 7/12 roof pitch

Available with flashing kit or
powder coat option*

*powder coat option available in 28 colors

**COUPLA & WHEATHER VEINS ARE SPECIAL ORDER.
PLEASE ALLOW 5 BUSINESS DAYS FOR SHIPPING.
OPTIONAL DROP SHIP TO LOCATION.**



48" octagon cupola
w/ windows



HAVE QUESTIONS? GIVE US A CALL TODAY AT 1-877-822-3530.



FAX US YOUR ORDERS AT (701) 749-5304 OR (701) 212-4392

RV400

Ridg-Vent®

4' long high profile ventilator

RV900

Ridg-Vent®

10' long high profile ventilator

- 1 " Bird Screen
- 2 Outer Band
- 3 Top Brace
- 4 Diverter
- 5 Lower Brace (900 only)
- 6 Lower Band
- 7 Damper (optional)
10' cable included w/ damper
- 8 Weather Seal

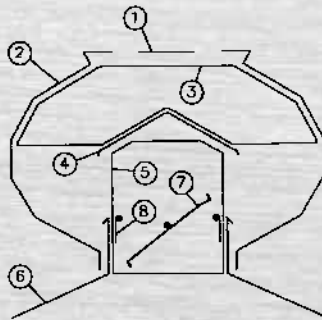

DAMPER RODS: 5/16" plated steel

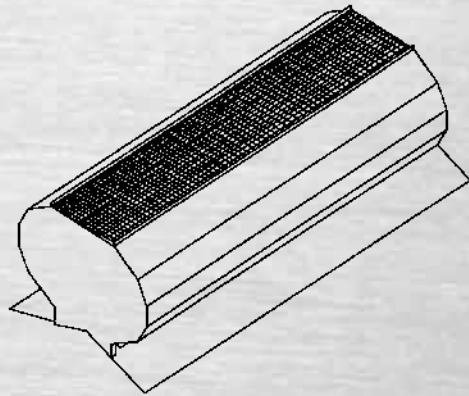

RV400 weight:
30 lbs. w/o Damper
33 lbs w/ Damper

RV900 weight:
78 lbs. w/o Damper
85 lbs. w/ Damper

MODEL No.	THROAT SIZE	FREE AREA (SQ FT)	STACK HEIGHT	CFM @ 15° TEMP DIFF	CFM @ 20° TEMP DIFF	CFM @ 25° TEMP DIFF
RV-400	9.0"	3.0	10.0'	550	680	765
RV-400	9.0"	3.0	20.0'	750	960	1070
RV-400	9.0"	3.0	30.0'	900	1170	1330
RV-400	9.0"	3.0	40.0'	1085	1350	1510
RV-900	9.0"	7.50	10.0'	1380	1550	1700
RV-900	9.0"	7.50	20.0'	1890	2150	2380
RV-900	9.0"	7.50	30.0'	2250	2680	2962
RV-900	9.0"	7.50	40.0'	2710	3070	3350

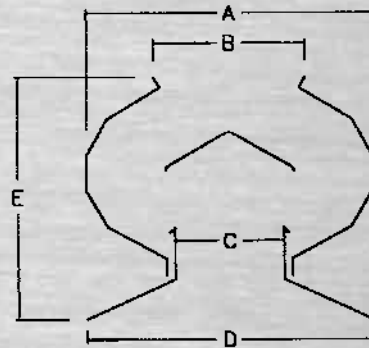

MODEL	DIM. "A"	DIM. "B"	DIM. "C"	DIM. "D"	DIM. "E"	LENGTH
RV-400	21"	10"	9"	21"	13.25"	4' - 0"
RV-900	21"	10"	9"	21"	13.25"	10' - 0"

R100 RIDGE VENT IN STOCK. ALL OTHERS CAN BE CUSTOM ORDERED. PLEASE ALLOW 5 BUSINESS DAYS FOR SHIPPING.

HAVE QUESTIONS? GIVE US A CALL TODAY AT 1-877-822-3530.





Specializing in Products for the Post Frame Industry

THE INDUSTRY'S LEADING MANUFACTURER OF NATURAL VENTILATION PRODUCTS



- We offer a large color palette to match most roll formers metal panels
- All metal edges are hemmed for strength and easier handling
- No raw metal edges, you'll never have red rust staining your roof
- Use MWI ventilation worksheet to determine proper quantity of vents for either an attic or entire building ventilation system
- Over 100 colors available

HAVE QUESTIONS? GIVE US A CALL TODAY AT 1-877-822-3530.



FAX US YOUR ORDERS AT (701) 749-5304 OR (701) 212-4392



STEEL AND ALUMINUM SOFFIT TRIM SYSTEMS

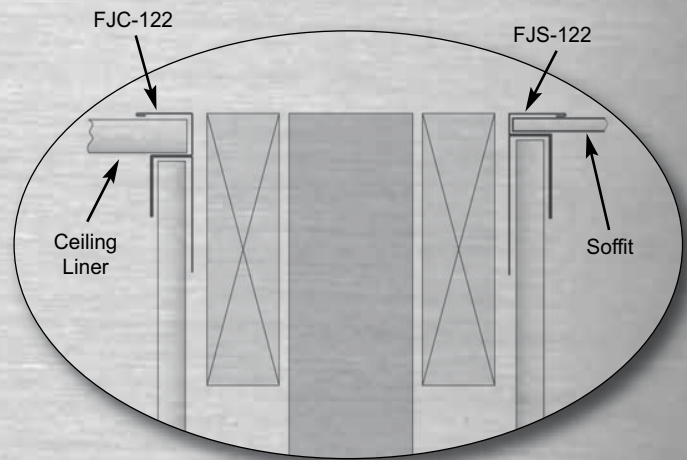
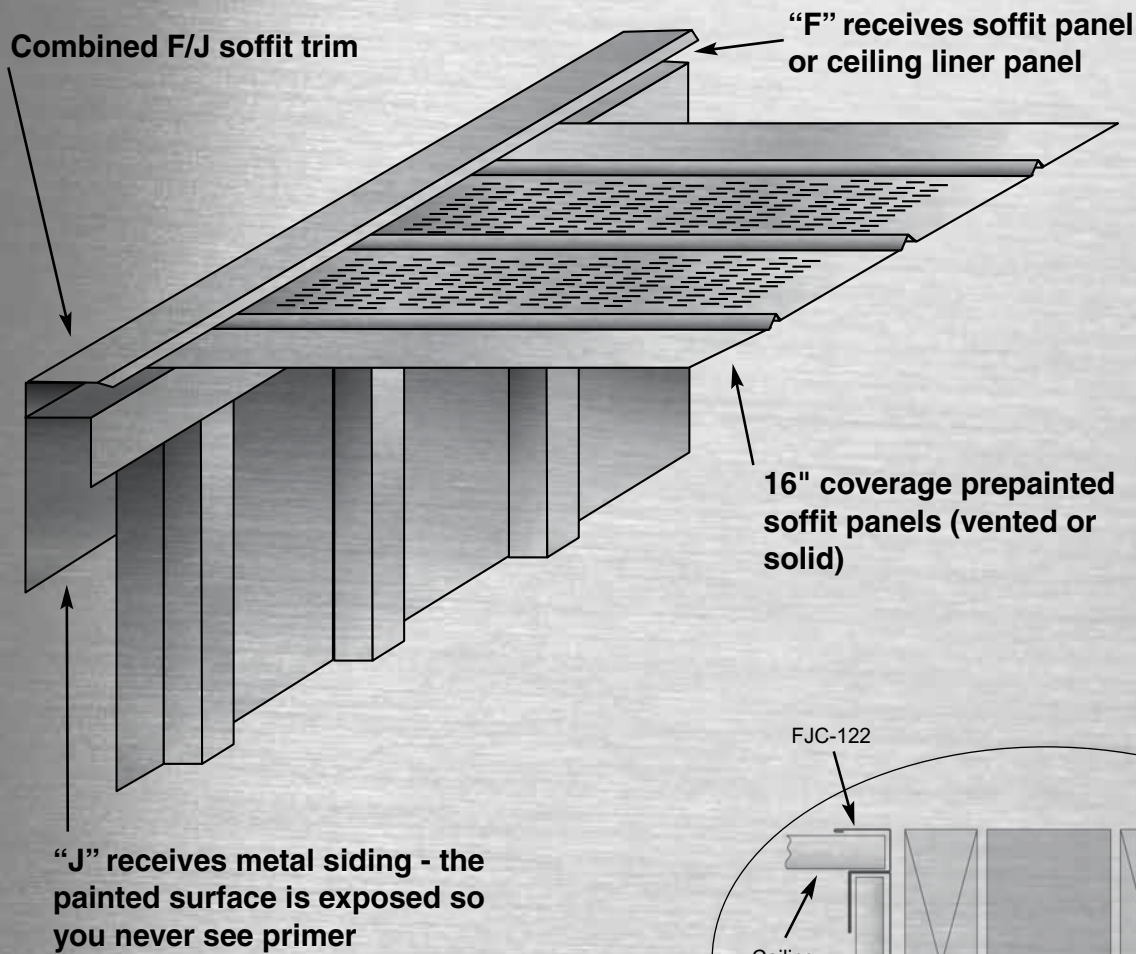

Soffit

- * Available in prepainted steel or aluminum
- * Precut lengths (12" or 24" standard)
- * Vented or solid panels
- * 12" panel provides 7.5 sq. in. of free area per foot
- * 24" panel provides 15 sq. in. of free area per foot

Trim

- * The combined F/J trim is available in two sizes to receive either the soffit panel or a ceiling liner panel
- * 3/8" J trim available to trim angles and corners
- * 3/8" F trim available for residential or wood siding.

HAVE QUESTIONS? GIVE US A CALL TODAY AT 1-877-822-3530.

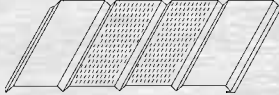
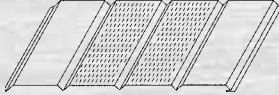
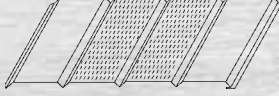
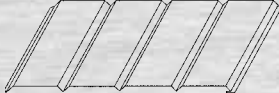

MODEL NUMBER	DESCRIPTION		LENGTH	PCS PER CARTON
S144 S144A	144" LONG - 16" WIDE COVERAGE SOFFIT PANEL - STEEL SOFFIT PANEL - ALUMINUM		144" 144"	12 12
S12 S12A	11.75" LONG - 16" WIDE COVERAGE PRECUT SOFFIT PANEL - STEEL PRECUT SOFFIT PANEL - ALUMINUM		11.75" 11.75"	30 30
S24 S24A	23.75" LONG - 16" WIDE COVERAGE PRECUT SOFFIT PANEL - STEEL PRECUT SOFFIT PANEL - ALUMINUM		23.75" 23.75"	15 15
	SOLID SOFFIT AVAILABLE IN STEEL OR ALUMINUM IN THE SAME LENGTHS AS ABOVE			

Special Cut Lengths are available. Sizes range from 7" to 144". Please call for details!

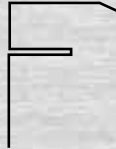
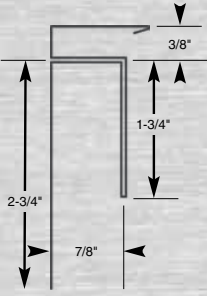
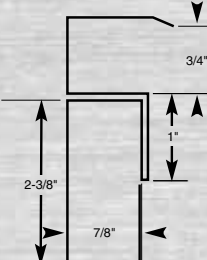
J 3/8 - 120	3/8" "J" TRIM - STEEL		120"	21
F 3/8 - 120	3/8" "F" TRIM - STEEL		120"	36
FJS-122	COMBINED FJ TRIM FOR SOFFIT WITH 1 3/4" COVERAGE - STEEL		122"	12
FJC-122	COMBINED FJ TRIM FOR CEILING LINER PANEL - STEEL		122"	12

HAVE QUESTIONS? GIVE US A CALL TODAY AT 1-877-822-3530.



FAX US YOUR ORDERS AT (701) 749-5304 OR (701) 212-4392



A RCADIAN HORSE STALL SYSTEMS



HAVE QUESTIONS? GIVE US A CALL TODAY AT 1-877-822-3530.



Specializing in Products for the Post Frame Industry



THE INDUSTRY'S LEADING MANUFACTURER OF ARCADIAN DOORS

BALE DOORS, DUTCH DOORS, FRENCH DOORS, SLIDING DOORS

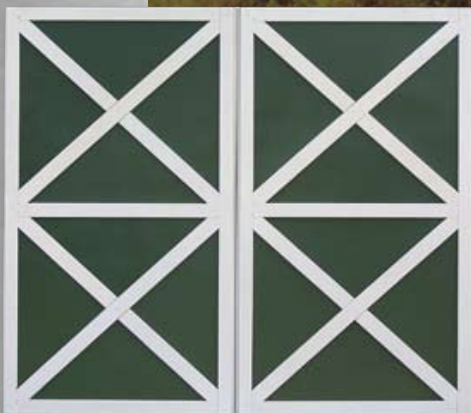

- All doors are fabricated from 16 gauge galvaneal
- Dutch Doors & Bale Doors feature one piece laser cut design
- Sliding doors are available in assembled or kit form

HAVE QUESTIONS? GIVE US A CALL TODAY AT 1-877-822-3530.



FAX US YOUR ORDERS AT (701) 749-5304 OR (701) 212-4392

RoofBoots™: the supreme flashing system.

Durable, flexible...and Weather-tite™ to boot.



20
YEAR
WARRANTY

High temperature roof boot shown here

- Easy, on-site customization
- Maximum resistance to ozone/ultraviolet weathering
- Flexible base forms seal with most panels
- EPDM or Silicone sleeve accommodates expansion/contraction
- Lots of color choices
- 20-year warranty

Is there a roof flashing system that conforms to virtually any roof panel, weathers the elements and maintains its tight seal, gives you compounded, color, and size choices, and comes with a 20-year warranty? You bet your boots!

So installation is simple: choose the pipe opening and trim the sleeve, slide the boot over the pipe, form to the roof profile, apply sealant, and fasten to complete the installation.

In addition to the sleeve compound options, you can also choose from round or square base, from Marco's full selection of wraparound retrofit boots, many sizes, and from black, grey or several other colors.

Marco's RoofBoots™ are made with clearly marked sleeves which can be cut on-site to easily customize and precisely fit the pipe diameter you need. The sleeves come in two different compounds—EPDM 500 and Silicone—designed specifically for the maximum resistance to weathering due to ozone and ultraviolet light.



And with flashing that weathers the elements so completely and conforms to seal so tightly, it's no wonder RoofBoots™ come with a 20-year warranty.

Choose Marco RoofBoots™, and you'll get a real kick out of how well your next roof project goes.

The base on RoofBoots™ is flexible and designed to form a seal on all types of roofing surfaces (including metal, plastic, tile, and more), and on almost any panel configuration and roof pitch, regardless of the pipe location.

ROOF BOOTS

Elements of the Marco WEATHER-TITE™ SYSTEM

HAVE QUESTIONS? GIVE US A CALL TODAY AT 1-877-822-3530.



Step-by-step installation



So installation is simple: choose the pipe opening and trim the sleeve, slide the boot over the pipe, form to the roof profile, apply sealant, and fasten to complete the installation.

Marco's RoofBoots™ are made with clearly marked sleeves which can be cut on-site to easily customize and precisely fit the pipe diameter you need. The sleeves come in two different compounds—EPDM 500 and Silicone—designed specifically for the maximum resistance to weathering due to ozone and ultraviolet light.

The base on RoofBoots™ is flexible and designed to form a seal on all types of roofing surfaces (including metal, plastic, tile, and more), and on almost any panel configuration and roof pitch, regardless of the pipe location.

In addition to the sleeve compound options, you can also choose from round or square base, from Marco's full selection of wraparound retrofit boots, many sizes, and from black, grey or several other colors.

9 sizes, 10 colors



ROOF BOOTS™

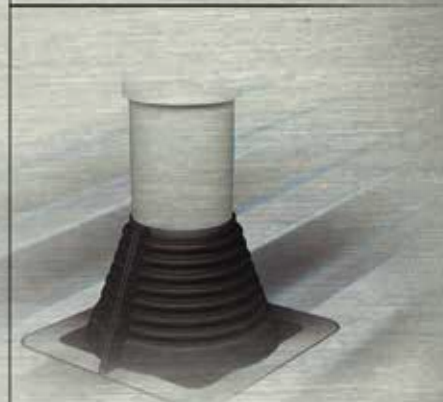
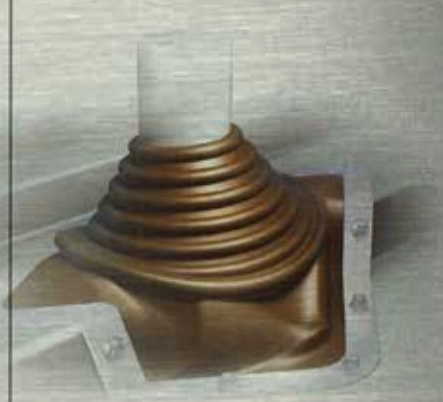
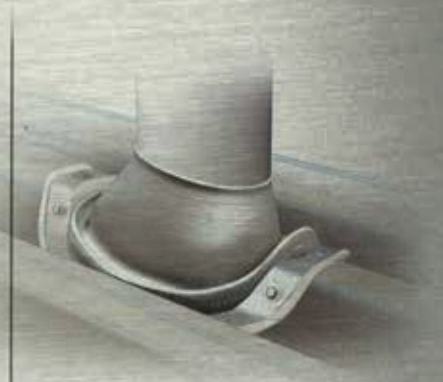

HAVE QUESTIONS? GIVE US A CALL TODAY AT 1-877-822-3530.



FAX US YOUR ORDERS AT (701) 749-5304 OR (701) 212-4392

SIZING CHART

Check diameter of pipe. Select the appropriate ROOFBOOTS™ product for pipe or duct diameter. For extreme pitch or surface irregularity select next larger size. Choose the compound required, then refer to the part number for the ROOFBOOTS™ product desired.

PIPE RANGE	COMPOUND	PART #	FLASHING DETAILS	
#1 1/4"-2 1/2" (6.35-63.5)	Black EPDM	RD101BE	A Top opening diameter	Closed
	Grey EPDM	RD101GG	B Overall height	2.77" (70.4 mm)
	Red Silicone	RD101RG	C Base diameter	4.75" (120.7 mm)
#2 1 3/4"-3" (44.5-76.2 mm)	Black EPDM	RD201BE	A Top opening diameter	1.44" (36.5 mm)
	Grey EPDM	RD201GG	B Overall height	3.35" (89.7 mm)
	Red Silicone	RD202RG	C Base diameter	6.21" (157.7 mm)
#3 1/4"-5" (6.35-127 mm)	Black EPDM	RD301BE	A Top opening diameter	Closed
	Grey EPDM	RD301GG	B Overall height	3.64" (92.5 mm)
	Red Silicone	RD302RG	C Base diameter	7.74" (196.6 mm)
#4 3"-6 1/4" (76.2-158.8 mm)	Black EPDM	RD401BE	A Top opening diameter	2.38" (60.5 mm)
	Grey EPDM	RD401GG	B Overall height	5.05" (128.3 mm)
	Red Silicone	RD402RG	C Base diameter	9.26" (235.2 mm)
#5 4 1/4"-7 3/4" (108-196.9 mm)	Black EPDM	RD501BE	A Top opening diameter	3.50" (88.9 mm)
	Grey EPDM	RD501GG	B Overall height	4.43" (112.5 mm)
	Red Silicone	RD502RG	C Base diameter	10.75" (273.17 mm)
#6 5"-9" (127-228.6 mm)	Black EPDM	RD601BE	A Top opening diameter	4.25" (108 mm)
	Grey EPDM	RD601GG	B Overall height	5.60" (142.2 mm)
	Red Silicone	RD602RG	C Base diameter	12.50" (317.5 mm)
#7 6"-11" (152.4-279.4 mm)	Black EPDM	RD701BE	A Top opening diameter	4.50" (124.5 mm)
	Grey EPDM	RD701GG	B Overall height	5.64" (143.3 mm)
	Red Silicone	RD702RG	C Base diameter	14.60" (370.8 mm)
#8 7"-13" (177.8-330.2 mm)	Black EPDM	RD801BE	A Top opening diameter	5.80" (147.3 mm)
	Grey EPDM	RD801GG	B Overall height	7.53" (191.3 mm)
	Red Silicone	RD802RG	C Base diameter	16.5" (419.1 mm)
#9 9"-19" (228.6-482.6 mm)	Black EPDM	RD901BE	A Top opening diameter	7.45" (189.2 mm)
	Grey EPDM	RD901GG	B Overall height	8.09" (205.5 mm)
	Red Silicone	RD902RG	C Base diameter	75.25" (641.4 mm)

PIPE RANGE	COMPOUND	PART #	FLASHING DETAILS	
Min. 1/8"-3/4" (3-20 mm)	Black EPDM	SQ051BA	A Top opening diameter	1/16"
#1 1/4"-2" (6-50 mm)	Black EPDM	SQ101BA	B Cut to suit pipe size	1/8"-3/4"
	Grey EPDM	SQ101GA	C Base diameter	2 1/4"
	Red Silicone	SQ101RA	A Top opening diameter	Closed
#2 1 1/4"-3" (32-76 mm)	Black EPDM	SQ201BA	B Cut to suit pipe size	1/4"-2"
	Grey EPDM	SQ201GA	C Base diameter	4 1/4"
	Red Silicone	SQ202RA	A Top opening diameter	7/8"
#3 1/4"-4" (6-102 mm)	Black EPDM	SQ301BA	B Cut to suit pipe size	1 1/4"-3"
	Grey EPDM	SQ301GA	C Base diameter	6"
	Red Silicone	SQ302RA	A Top opening diameter	Closed
#4 3"-6" (76-152 mm)	Black EPDM	SQ401BA	B Cut to suit pipe size	1/4"-4"
	Grey EPDM	SQ401GA	C Base diameter	8"
	Red Silicone	SQ402RA	A Top opening diameter	2 1/2"
#5 4"-7" (102-178 mm)	Black EPDM	SQ501BA	B Cut to suit pipe size	3"-6"
	Grey EPDM	SQ501GA	C Base diameter	10"
	Red Silicone	SQ502RA	A Top opening diameter	3 1/2"
#6 5"-9" (127-228 mm)	Black EPDM	SQ601BA	B Cut to suit pipe size	4"-7"
	Grey EPDM	SQ601GA	C Base diameter	11"
	Red Silicone	SQ602RA	A Top opening diameter	4"
#7 6"-11" (152-280 mm)	Black EPDM	SQ601BA	B Cut to suit pipe size	5"-9"
	Grey EPDM	SQ601GA	C Base diameter	12"
	Red Silicone	SQ602RA	A Top opening diameter	5"
#8 7"-13" (178-330 mm)	Black EPDM	RD701BE	B Cut to suit pipe size	6"-11"
	Grey EPDM	RD701GG	C Base diameter	14"
	Red Silicone	RD702RG	A Top opening diameter	6"
#9 10"-18" (254-467 mm)	Black EPDM	SQ801BA	B Cut to suit pipe size	7"-13"
	Grey EPDM	SQ801GA	C Base diameter	17"
	Red Silicone	SQ802RA	A Top opening diameter	8 1/2"
Max. 13"-26" (330-660 mm)	Black EPDM	SQ901BA	B Cut to suit pipe size	10"-18"
	Grey EPDM	SQ901GA	C Base diameter	25"
	Red Silicone	SQ902RA	A Top opening diameter	11"
	Black EPDM	SQ951BA	B Cut to suit pipe size	13"-26"
	Grey EPDM	SQ951GA	C Base diameter	34"
	Red Silicone	SQ952RA		

ISO QUALITY PRICE AND AVAILABILITY

Advanced Ozone Resistance tested
High Temperature Resistance tested to: intermittent
High Temperature Resistance tested to: continuous
Low Temperature Resistance tested
Tensile Set maximum
Compression Set maximum

2 COMPOUNDS/ 9 SIZES
Available in two compounds to handle virtually all job applications.

EPDM 500	SILICONE
70 hours @ 500 pphm	70 hours @ 500 pphm
+135°C (+275°F)	+260°C (+500°F)
+100°C (+215°F)	+225°C (+437°F)
-55°C (-65°F)	-74°C (-100°F)
10MPa (1450 psi)	5 MPa (700 psi)
25%	50%

*Complete specification data and testing methods are available upon request.

As part of a standard classification system for rubber products these general specifications present conservation engineering miniatures which should be used for design criteria.

General recommendations must be tested for extreme applications.

EPDM ROOFBOOTS™ ENGINEERING SPECIFICATIONS
ASTM D2000 MG BA 510 A1 B13 C12 F17 Z1 Z2 Z3 Z4 Z5 Z6 Z7

GRADE 3

TYPE B	General Tes Temp 100°C
Class A	Volume Swell no req
5	50 Durometer (range)
10	Tensile 10 MPa (approx. 1450 psi)
A14	Heat Aging 70 hrs @ 100°C
B13	Compression Set 22 hrs @ 70°C Max 25% ASTM D395B
C12	Ozone Resistance 70 hrs @ 50pphm ASTM D1171 100% Quality Retention
F17	Low Temperature Brittleness 3 min @ -40°C Pass ASTM D2137 A, 9, 3, 2
Z1	55 Durometer (specific target)
Z2	EPDM (specific elastomer)
Z3	Horizontal Flame Resistance, UL 94 Not to exceed 3"/min
Z4	Ozone Resistance Advanced Requirement
Z5	70 hrs @ 500pphm @ 100°F Accelerated Weathering Resistance (U.V. Light), ASTM G-53
Z6	Tear Resistance, ASTM D-624, die "D"
Z7	Resistance to Discoloration, ASTM

SILICONE ROOFBOOTS™ ENGINEERING

ASTM D2000 M4 GE 505 A19 B37 C12 F19 G11 Z1 Z2 Z3 Z4

GRADE 4

Type G	General Tes Temp 225°C
CLASS E	Volume Swell Max 80%
5	50 Durometer (range)
05	Tensile 5 MPa (minimum 725 psi)
A19	Heat Aging 70 hrs @ 225°C
B37	Change in Hardness max +10 pts Change in Tensile max -30% Change in Ultimate Elongation max -30%
C12	Compression Set 22 hrs @ 175°C Max 50% ASTM D395B
F19	Ozone Resistance 70 hrs @ 50pphm ASTM D1171 Low Temperature Brittleness
G11	3 min @ -55°C pass ASTM D2137 A, 9, 3, 2
Z1	Tear Resistance, ASTM D-624, die "B"
Z2	55 Durometer (specific target)
Z3	Silicone (specific elastomer)
Z4	Horizontal Flame Resistance, UL 94 not to exceed 3"/min Ozone Resistance Advanced Requirement 70 hrs @ 500pphm @ 100°F



HAVE QUESTIONS? GIVE US A CALL TODAY AT 1-877-822-3530.

ROOF BOOTS™

Marco's supreme flashing system.

Easy, on-site customization

- Just choose the pipe opening size and quickly cut to fit the pipe diameter you need.

Maximum resistance to ozone/ultraviolet weathering

- Get maximum resistance to ozone and ultraviolet light weathering.

Flexible base forms seal with most panels

- You can quickly use the base's flexibility to conform to form a seal on just about any panel configuration, roof pitch, or pipe location.

EDPM or Silicone sleeve accommodates expansion/contraction

- Choose either dependable compounded sleeve—the flexible sleeves accommodate vibration and pipe movement caused by expansion/contraction.

Three shapes, many sizes

- Choose round or square base, wraparound retrofit, and from a long list of sizes, so you can be assured there's a RoofBoots™ flashing for your specific project.

Choose from several colors

- Black or grey, or several other colors to work with any roof.

20-year warranty

- Marco stands behind RoofBoots' reliability with a 20-year warranty.

Specification Data

	EPDM 500	SILICONE
ADVANCED OZONE RESISTANCE tested	70 hours @ 500 pphm	70 hours @ 500 pphm
HIGH TEMPERATURE RESISTANCE		
Tested to: intermittent	+100°C (+275°F)	+135°C (+275°F)
Tested to: continuous	+225°C (+437°F)	+260°C (+500°F)
LOW TEMPERATURE RESISTANCE tested	-55°C (-65°F)	-74°C (-100°F)
TENSILE SET maximum	10 MPa (1450 psi)	5 MPa (700 psi)
COMPRESSION SET maximum	25%	50%

Complete specification data and testing methods are available upon request.

RoofBoots™ represent yet another Marco Industries technological development in bringing you innovative, higher quality, and more economical products for the building industry.

To place your order: 1.800.800.8590 | marcoindustries.com | info@marcoindustries.com

HAVE QUESTIONS? GIVE US A CALL TODAY AT 1-877-822-3530.



FAX US YOUR ORDERS AT (701) 749-5304 OR (701) 212-4392

Precise fit Closure.

- Full ¼" bead once installed of adhesive applied
- Profiles for every application
- 6 different foams
- Thickness variety
- Better UV resistance

Marco Industries' Closure-Foam™ gives you so many options when ventilation isn't an issue for your project. 400 profiles are already in our line... and if yours isn't one of them, we make custom ordering incredibly easy. So you get precisely the fit and foam you need for your exact application.

Marco's M63™ Industrial Adhesive. It's a big deal, because applied to all products is a **full ¼" bead** once installed so it stays put during installation and you no longer need to worry about blow away problems. The M63™ adhesive is super strong and specially designed to **adhere even in subfreezing temperatures and to wet surfaces.**

You choose application of the adhesive strip to the flat or the ribbed side of the closure strip. And with Marco's glue line automation, you can depend on a **fast turnaround** after ordering.

You can also choose **dovetails, available with most profiles.** Interlocking dovetails eliminate gaps, ensure a snug end-to-end fit, and are available with or without the M63™ Industrial Adhesive. What's more, **all scrap foam parts resulting from die-cuts are removed** leaving you with **less job site cleanup.**

Closure-Foam™ is **economically priced**, but you won't sacrifice quality. For example, M-Cell thick crosslink polyethylene foam is heat-treated, creating a unique coating which gives it **better UV resistance, better durability** than the industry standard. In fact, the latest ozone literature confirms that our 1.5 density foam provides **better UV stability** than competitive products with a 2.0 density.

This protective coating forms during the heat-treated process of manufacturing and shields the product from harmful UV rays.

CLOSURE-FOAM™

One element of the Marco WEATHER-TITE™ SYSTEM

HAVE QUESTIONS? GIVE US A CALL TODAY AT 1-877-822-3530.



Closure Foam™

Marco's Complete Line of High Quality Foam Closures

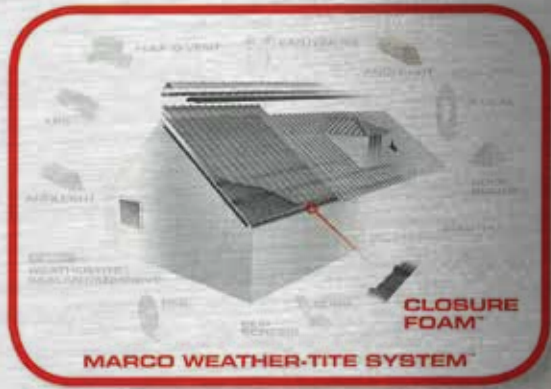

Typical application



Interlocking dovetails



UV resistance

Property	Test	Procedure	Units	LD24
Nominal Density - Skin/Skin		BS ISO 7214 1998	kg/m³	24
Cell Size - Typical Diameter		Internal	mm	0.3
Compression Stress-Strain		BS ISO 7214 1998		
10% compression			kPa	34
25% compression			kPa	53
40% compression			kPa	85
50% compression			kPa	118
Compression Set		BS ISO 7214 1998		
25% comp., 22hr, 23°C		25 mm cell-cell		
1/2 hr recovery			% set	13
24hr recovery			% set	5
50% comp., 22hr, 23°C				
1/2 hr recovery			% set	27
24hr recovery			% set	19
Tensile Strength		ISO 7214 1998	kPa	320
Tensile Elongation			%	130
Tear Strength		BS EN ISO 8067 1995	N/m	495
Shore Hardness OO Scale		ISO 868 1985	OO	50
10mm cell/cell thickness				
Recommended operating temperature range*		Internal	°C	+100 max -70 min
Thermal Conductivity mean temp of 10°C		ISO 8302 1991	W/m.K	0.0392
Flammability				
Automotive		FMVSS.302 - Burn rate	<100mm/min.	Pass: 12 mm and thicker
Horizontal Burn Rate		ISO 7214 1998		
5mm thick			mm/sec	2.1
13mm thick			mm/sec	1.5
Durometer		50	Shore OO	
Water			lbs/ft3	5%

Additional colors are available upon request.

CLOSURE-FOAM™ products represent yet another Marco Industries technological development in bringing you innovative, higher quality, and more economical products for the building industry.

To order: 1.800.800.8590 | MarcoIndustries.com | info@MarcoIndustries.com

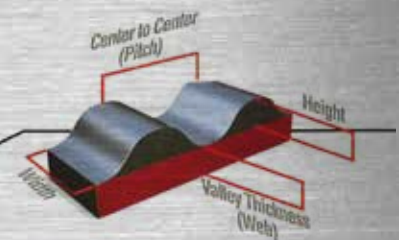

Terms for help in purchasing process

HAVE QUESTIONS? GIVE US A CALL TODAY AT 1-877-822-3530.



FAX US YOUR ORDERS AT (701) 749-5304 OR (701) 212-4392

**Remove the re-roofing
danger, expense, and
hassle of wood furring
with RE2™**

Roll away re-roofing hassles!

- Eliminate tear-off
- Easy to install
- No more warped wood furring
- Cost comparable to wood, plus increases profitability
- Won't rot, corrode, or crease metal

Re-roofing over an existing composition roof used to mean purchasing a load of 1" x 4" lumber, and then struggling to attach those wood furring strips to the old roof. After the new metal roof installation on the wood spacers, more problems were likely to develop: The wood spacers warped and caused the metal to crease. Or they would rot or corrode the metal.

Use RE2 instead of wood spacers and you'll solve the re-roofing problems described above and much more.

The revolutionary RE2 is manufactured with high density polyethylene foam. It's lightweight, yet strong and won't rot or corrode the metal roof you install on top of it, nor will it warp which causes the metal to crease.

RE2 is sold in two 150-foot easy-to-handle rolls. You just roll it across the old shingled roof, tack it down (with the 50 nails included), and install the metal roof on top. RE2 acts as a spacer between the old shingles and the new metal roof, providing air flow and ventilation.

The initial cost of RE2 is comparable to using wood spacers. Yet, it's easy to handle and easy to install (heavy tools not required!), so it increases productivity.

Since RE2 won't warp like wood, you'll experience fewer customer callbacks. And our own customers report that insurance risks are even reduced with RE2.

So if you're looking for a way to resolve on-site retrofit problems, choose the innovative RE2 for your next re-roofing job. It's re-markable!



WEATHER-TITE™ SYSTEM

HAVE QUESTIONS? GIVE US A CALL TODAY AT 1-877-822-3530.





Revolutionary spacer system uniquely designed for metal roofing.

Eliminates tear-off

Use RE2 as a spacer system in place of wood so you can install the new metal roof directly on top of RE2.

Provides air flow and ventilation

Retro-Ease spacers allow air flow and ventilation between the old composition roof and the new metal roof.

Lightweight yet durable.

RE2 is manufactured with high density cross-linked polyethelene foam which makes it lightweight, but won't rot or corrode metal.

Won't warp like wood furring.

Wood spacers warp and cause metal roofing to crease. RE2 will not warp.

Easy to handle, easy to install.

Your crew will get the re-roofing job done faster, easier, and safer with RE2.

Cost-effective.

At a price comparable to wood spacers and so fast and easy to install, RE2 is extremely cost-effective.



Typical Physical Properties

Physical Property	Test Method	Value
Compressive Strength	ASTM D3575-00	3.8
-Vertical direction (psi)		
Compression Set (%)	ASTM D3575-00	< 30
Tensil Strength (psi)	ASTM D3575-00	58
	suffix T (md / cmd)	30
Elongation	ASTM D3575-00	86
	suffix T (md / cmd)	60
Tear Resistance (lb/in)	ASTM D3575-00	11
	suffix G (md / cmd)	17
Density Range (lb/ft ³)	ASTM D3575-00	1.5-1.9
Water Absorption (lb/ft ³)	ASTM D3575-00	< 0.1
	suffix L	
Thermal Stability	ASTM D3575-00	< 5%
	suffix S	
Contact Corrosivity	Method 3005 FED	None
(Alum. Plate)	STD. 101	
Static Decay	EIA STD. 541	< 2 sec.
(anti-static grade)	Appendix F	
Surface Resistivity	EIA STD. 541	1.0 x 10 ⁹ - 1.0 x 10 ¹²
(anti-static grade)	section 4.3	
Thermal Conductivity k-value	ASTM C518-91	0.35-0.42
(BTU-IN / HR-FT ² -°F)		
Thermal Resistance R - Value	ASTM C518-91	1.30-1.60
(HR-FT ² -°F / BTU)		

RE2™ represents yet another Marco Industries technological development in bringing you innovative, higher quality, and more economical products for the building industry.

To place your order: 1.800.800.8590 | marcoindustries.com | info@marco-industries.com

HAVE QUESTIONS? GIVE US A CALL TODAY AT 1-877-822-3530.



FAX US YOUR ORDERS AT (701) 749-5304 OR (701) 212-4392

For any shaped gap in
the construction of metal
buildings, doors and
windows, concrete, wood,
and more...

Hips? Valleys?

Fill 'er up with X-Seal.



- Expands from 1/4" to 1-1/4"
- Follows, flexes, expands, compresses to fit
- UV stable
- Won't dry out or extrude like caulk or butyl tapes
- Highly resistant to bugs and vermin
- Economical
- Maintains seal in heat and cold

Filling troublesome gaps during construction has never been easier.

X-Seal comes compressed at just one-quarter inch, on an easy-to-handle roll. Cut the desired length of X-Seal, place X-Seal into the gap opening—even one with irregular hips and valleys—and remove the protective release paper. Now watch X-Seal slowly expand up to 1-1/4" to completely fill and seal the gap. (X-Seal expands more slowly in cold weather than in hot weather.)

As remarkably easy X-Seal is to install, it continues to remarkably deliver after installation.

X-Seal won't dry out and become hard or brittle. And it's highly resistant to bugs and vermin.

It won't extrude from joints like caulk or butyl tapes usually do. It conforms to a gap's contours so it really fills and seals. It maintains a seal during thermal expansion and contraction of building panels. It has excellent compressibility and recovery (for minimal compression set). It's a very good thermal and sound insulator. And there's no shrinkage or blow-out from closed-cell breakage with X-Seal.

With features like those, X-Seal's versatility makes it perfect for sealing gaps in so many construction projects:

- Joints and seams in metal construction
- Around doors and windows
- For control joints, expansion joints and isolation joints in concrete construction
- Civil and underground construction (highway and airport runways)
- Log and prefabricated homes
- Panel joints in precast panel construction

Try X-Seal Expandable Foam Tape just once on your next construction project. And the list of projects you'll want to use it on next will definitely expand.



SEAL

One element of the Marco WEATHER-TITE™ SYSTEM

Expandable Foam Tape

HAVE QUESTIONS? GIVE US A CALL TODAY AT 1-877-822-3530.





SEAL

Expandable foam tape.



Previous to expansion



Expanded

Expands to really fill the gaps.

- Easy to install, X-Seal expands from 1/4" to 1-1/4" when placed in the unwanted gap and you pull the pressure sensitive adhesive. Whether using it with a hip, valley, or ridge, X-Seal flexes, expands, and compresses to follow the profile and seal the gap.

Durable, reliable and permanent sealant for construction.

- Won't dry out or extrude like caulk and butyl tape. X-Seal is UV stable and actually maintains its seal during thermal expansion and contraction.

Creates a breathable seal.

- X-Seal holds the exterior out and the interior in, yet allows vapors to move through. A hermetic seal allows the absorption of moisture and when conditions permit, the slow release of moisture through evaporation.

Extremely versatile.

- X-Seal's features make it an excellent choice for many applications, between similar and dissimilar construction materials.

An economical choice.

- X-Seal is an economical alternative to conventional sealants.

Physical Characteristics

Description/Base/Color:	Precompressed, self-expanding pur-foam impregnated with a high quality modified acrylic, flame retardant emulsion. The base foam is black; other colors available.
Density:	10 lbs./cu. Ft. 150 kg/m3
Flammability:	UL 94 HF1, Self-Extinguishing, DIN 4102, B1 compression at 50%, B2 compressed
Temperature Stability Range:	-40°F to 212°F
Manufacturer's Lab:	(-40°C to 120°C)
Weather Resistancy:	Excellent
Compression Set:	Maximum 2%
Tensile Strength:	21.8 psi
Thermal Conductivity:	12,106 BTU (hr.) (ft2) (°F/ft)



Hips



Doors

X-Seal™ represents yet another Marco Industries technological development in bringing you innovative, higher quality, and more economical products for the building industry.

To place your order: 1.800.800.8590 | marcoindustries.com | info@marcoindustries.com

HAVE QUESTIONS? GIVE US A CALL TODAY AT 1-877-822-3530.



FAX US YOUR ORDERS AT (701) 749-5304 OR (701) 212-4392

Choose the sealant
that will stick around
before and after
installation.

Staying power

- High quality adhesive
- Joins metal to metal
- Seals around windows, doors, more
- Roll won't telescope from heat before installation
- Adhesive really holds hot metal panels



Marco Industries has created a high quality trimmable joint and end lap sealing tape that solves the adhesive failure problems associated with hot metal roofing and wall jobs.

Mastixtape™ is made with a superior adhesive which is **non-staining, permanently flexible,** and stays in place during extreme heat. It seals around windows, doors, roof vents, stacks, access doors and other penetration points.

The adhesive actually **prevents the product roll from "telescoping"**...a common problem when other adhesives get too hot and cause a tape roll to start losing its shape. Which then causes the installer more handling problems and installation time.

Then, once Weathertite™ Mastixtape™ is applied, it truly adheres to the metal roof panel and **stays in position even on the hottest days.** So you don't have to mess with a falling adhesive strip sliding down the hot metal roof before you can overlay the next roofing panel.

Don't sweat your next metal roofing job. Choose Weathertite™ Mastixtape™ and get the job done easier and faster, even on the hottest days.

MASTIX

One element of the Marco WEATHER-TITE™ SYSTEM

HAVE QUESTIONS? GIVE US A CALL TODAY AT 1-877-822-3530.



MASTIX

Metal to metal high quality sealing tape...that really stays in place.



Versatile

- Mastix is a trimmable end lap sealing tape that joins metal to metal, and seals around windows, doors, roof vents, stacks, access doors and other penetration points.

Prevents product telescoping.

- Mastix superior adhesive keeps the product roll intact and non-telescoping, even on hot days.



Keeps metal roofing panel in place

- Apply Mastix to a hot metal roofing panel. It will stay put, while you place the panel. No melting,



oozing adhesive allowing panels to slide and making your installation harder.

Non-staining, permanently flexible.

- Mastix won't stain, and it stays flexible, making it the perfect adhesive tape for almost every metal roof application.

Sizes Available

Size	Rolls / Case	Case / Pallet
3/32 x 3/8 x 45	45 / case	30 / pallet
3/32 x 1/2 x 45	22 / case	50 / pallet
3/32 x 3/4 x 45	24 / case	36 / pallet
3/32 x 1 x 45	24 / case	30 / pallet

Technical Characteristics

Chemical Product and Company Identification

Product Name: Mastix™ Butyl Tape
 Chemical Name: Isobutylene
 Chemical Family: Butyl Mixture

Health Hazard: 0-Minimal
 Flammability Hazard: 0-Minimal
 Reactivity Hazard: 0-Minimal

Hazardous Identification

- Based on data available to Marco Industries, none of the components in this product are considered hazardous according to OSHA Hazard communication Standard 29CFR 1910.1200.
- The Composition of this mixture is proprietary information. In the event of a medical emergency, compositional information will be provided to a physician or nurse.

Fire Hazards

Flash Point: >400°F (204°C)
 Method: Pensky Marten closed cup

Extinguishing Media: Dry chemical, Carbon dioxide, Foam, Water
 Special Fire-Fighting

Procedures: Large quantities of water will extinguish. Do not enter confined space without proper protective equipment.

Hazardous Combustion

Products: Carbon monoxide, Carbon dioxide.

Physical and Chemical Properties

Volatile (WL) %: 0
 Solubility in Water: Insoluble
 Specific Gravity (H2O=1): 1.59-1.64
 Evaporation Rate: Not applicable
 Appearance: Soft, pliable gum
 Color: Q-126 Off-white to gray
 Q-126BB Black
 Q-126-10 Off-white to gray
 Odor: None

Mastix™ represents yet another Marco Industries technological development in bringing you innovative, higher quality, and more economical products for the building industry.

To place your order: 1.800.800.8590 | marcoindustries.com | info@marcoindustries.com

HAVE QUESTIONS? GIVE US A CALL TODAY AT 1-877-822-3530.



FAX US YOUR ORDERS AT (701) 749-5304 OR (701) 212-4392



3361 134th Avenue SE
Tower City, ND 58071

Toll Free: 877-822-3530

Phone: 701-749-5301

701-749-5302

Fax: 701-749-5304

701-212-4392